

OGILVY CONSULTING

# Union of Humans

*The Future of the  
Millennial Generation  
in the Age of Automation*

Jess Kimball Leslie  
Chief Futurist

Ogilvy

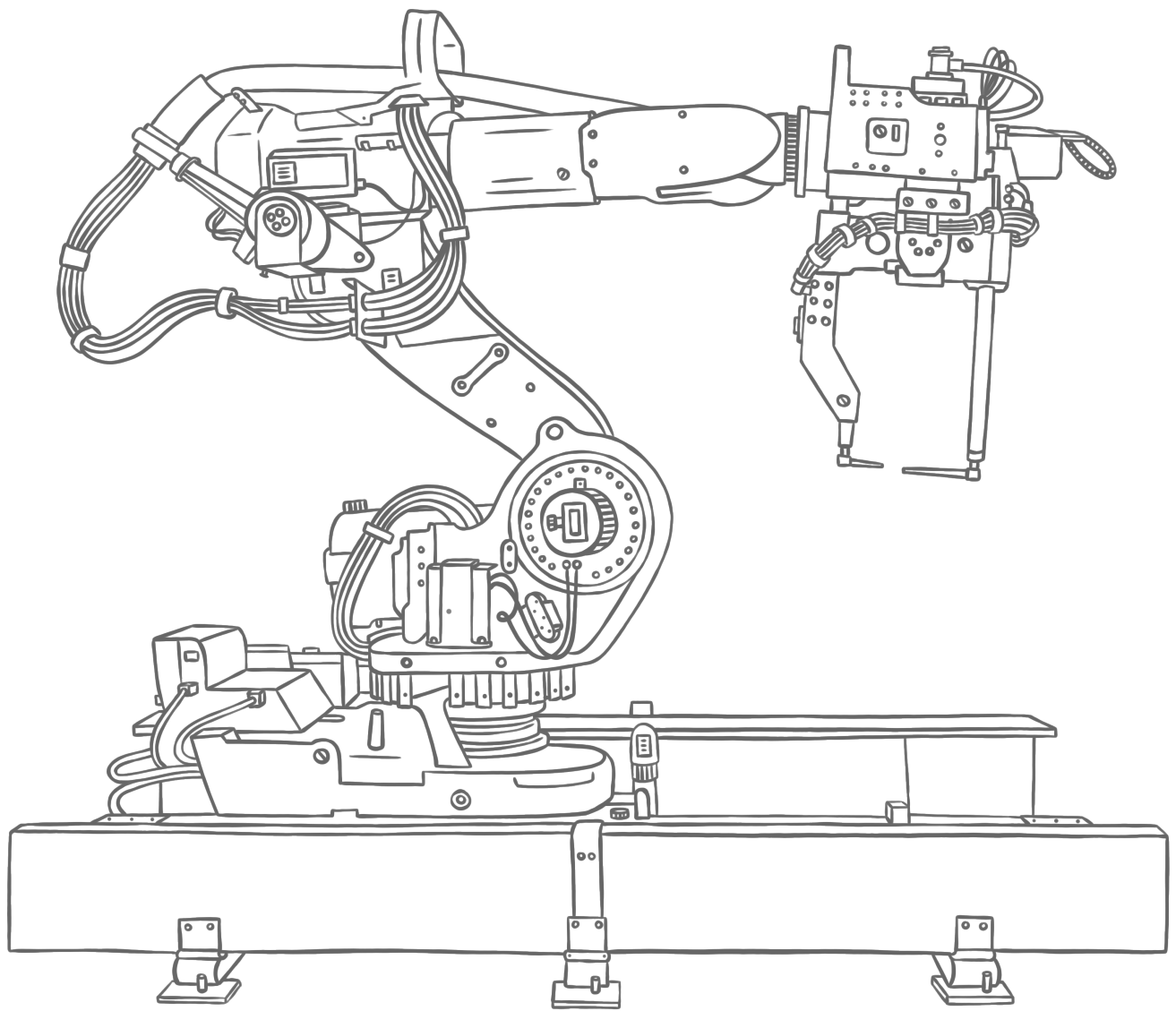

## Table of Contents

(00)	Prologue p. 4-23	A Look Back & A Look Forward <i>Reflections</i>
(01)	Chapter 1 p. 24-73	Millennials & the Economy <i>The Human Union</i>
(02)	Chapter 2 p. 74-91	Millennial Culture <i>Evolution &amp; Contradiction</i>
(03)	Chapter 3 p. 92-107	Millennials, Advertising, & Media <i>Drone or Billboard or Both?</i>
(04)	Chapter 4 p. 108-111	In Conclusion <i>The Adultings Will Be All Right</i>
(05)	Endnotes p. 112-118	Sources <i>Further Reading</i>





00 PROLOGUE

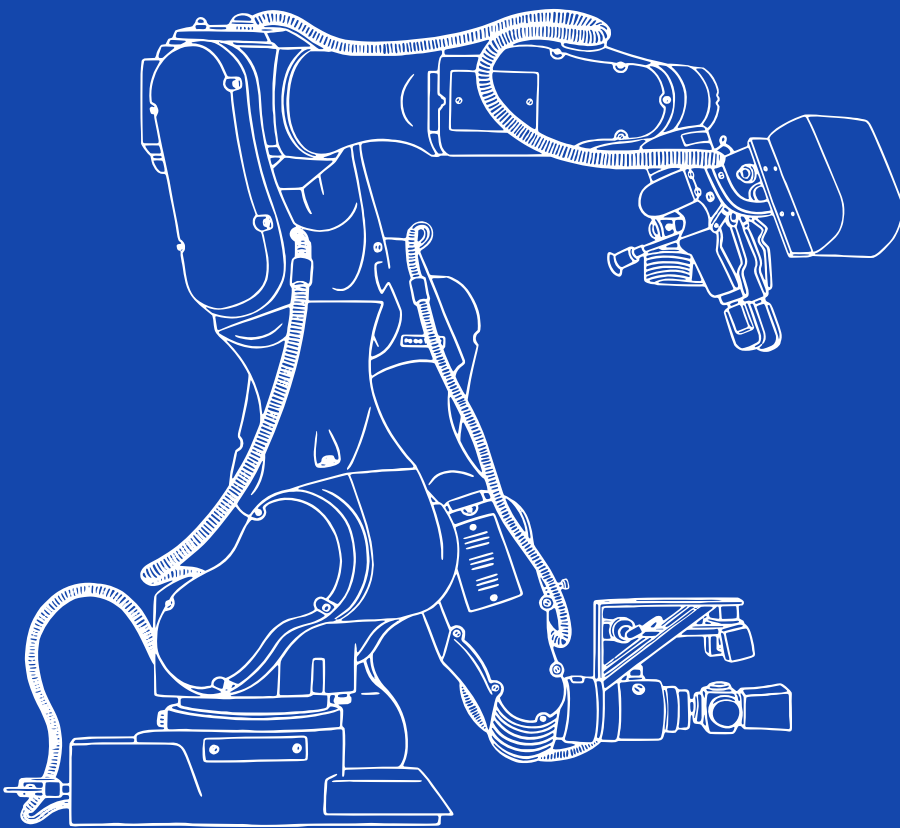

# A Look Back & A Look Forward

*Reflections*

## F.01—Inequality: A Huge Issue

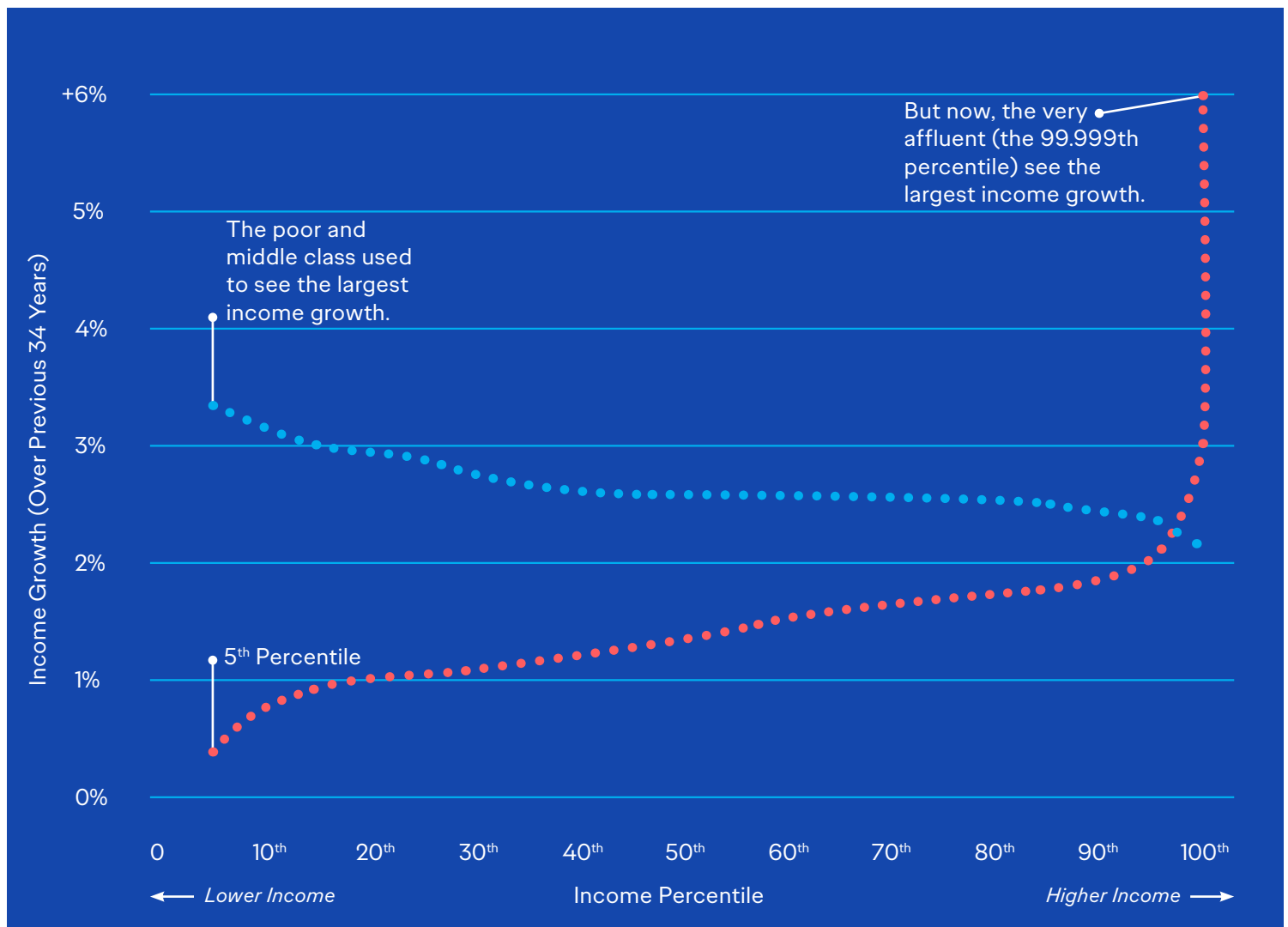

Figure 01

Source (Inequality, above): Leonhardt, David. "Our Broken Economy, in One Simple Chart." *New York Times*, August 7, 2017.

Source (Upward Mobility, next page): Chetty et al, *Science*, April 24, 2017.

● 1980  
● 2014

## A Look Back to 2015

### *The Year We Predicted Inequality Was About to Change Everything*

Back in 2015, Ogilvy Consulting authored a trend report on Millennials (“States of the American Millennial”)<sup>1</sup> that was structured around one overarching insight: inequality would soon become the Millennial generation’s key defining issue.

In reflecting on that report, what’s most intriguing is that its tone didn’t match the times. Back in 2015, Hillary was campaigning for her “inevitable” Presidential win, Obama was calmly demystifying healthcare for the “young invincibles,” and automation was not yet a word that appeared regularly in newspaper headlines. We hit the speaker circuit and kicked things off with a chart about wealth and opportunity divides cribbed from Thomas Piketty, and a headline that inequality was about to rear its ugly head in America. The room often became awkward.

Our 2015 report strictly **divided Millennial America into two factions**—the haves and the have-nots, the rich Millennials and poor Millennials. (Legal journalist Stephen Brill named these groups “the protected” and “the unprotected,” which is better nomenclature.)<sup>2</sup> We asserted that 2015’s status quo was wildly untenable. We quoted a 2014 editorial from *The Economist*, which questioned, “Why aren’t the poor storming the barricades?”<sup>3</sup> That’s what we were wondering, baffled, as we stared at the obvious behaviors of America’s greediest elite.

### *Upward Mobility*

In 1940, a child born in a typical U.S. household had a **90%** chance of earning more than his or her parents.

### *Downward Mobility: Fading Fast*

Today, a child born to a U.S. household has about a **50/50** chance to earn more than his or her parents.

We also anticipated a forthcoming era of super-companies, wherein we posited that the **“Fortune 500 would become the Fortune 5.”** “It’s not just that industries will be reinvented, it’s that they’ll cross-pollinate,” we wrote. Not long after, Amazon bought Whole Foods, Apple became a film studio, and Google built a car. By 2017, new research from The National Bureau of Economic Research coined the term “superstar firm,” defined as a global market situation wherein “industries are increasingly characterized by 'winner take most' competition, leading a small number of highly profitable (and low labor share) firms to command growing market share.”<sup>4</sup>

Continuing into that report’s findings, we discussed authenticated and unauthenticated identity within the context of **the rising power of Alphabet, Twitter and Facebook.** We foresaw that Millennials would be forced to protect the right to privacy, re-evaluating it as a tentpole of democratic society. We intuited that **the news industry was nearing a crucial turning point,** as its own widespread, nefarious practices (sponsored content, purposeful obfuscation, click-baiting, under-coverage of critical issues like systematic racial and gender discrimination, etc.) would provoke an industry-wide trust crisis.

In short, a lot of our predictions panned out. So it’s now time to update our thinking, and discuss some new predictions for the 2020 era.

## F.02—As Union Membership Rates Increase, Middle-Class Incomes Shrink

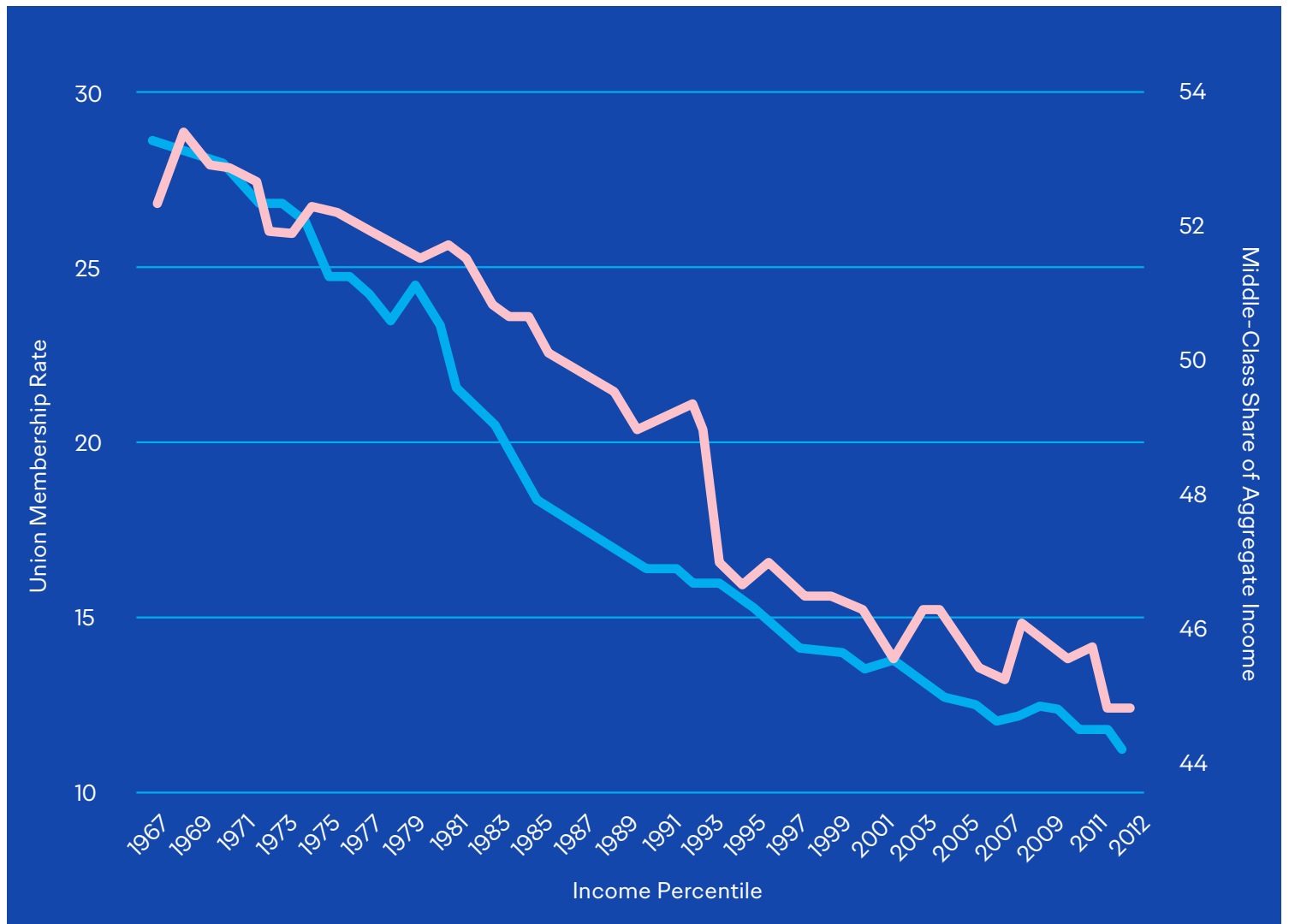

Figure 02

Source: Fairchild, Caroline. "Middle-Class Decline Mirrors the Fall of Unions in One Chart."

Huffington Post Business, September 2013 (Updated December 2017).

- Union Membership Rate 2014
- Middle-Class Share of Income

## A Look Forward to 2020

### *Building the Union of Humans*

It's not always fun or easy to understand an automating, fissuring, hyper-globalizing economy. It's not always comfortable to consider that decades-old safe and sage advice (“*Go to college!*”) might become totally obsolete—if we don't move quickly to curtail the privatization of our primary schools, and/or colleges fail to modernize their offerings.

However with great crisis comes great opportunity, and Millennials are well-equipped to handle the mammoth issues before them. They are, after all, the most educated, most connected generation in American history.

So why the emphasis on...*unions*? Well, we really need them, and Millennials happen to love them. As *The Nation* reports, across America in 2017 “nearly 860,000 workers under age 35 got hired, and nearly a quarter of those were union jobs.”<sup>5</sup> Additionally, despite the fact that unions “hemorrhaged middle-aged workers over the years—2017 actually saw an increase in members.” Young people know what The Economic Policy Institute has yet again concluded: “Collective bargaining is how working people gain a voice at work and the power to shape their working lives.”<sup>6</sup>

When certain elder, Caucasian segments of the U.S. population speak of the 1950s-1970s as being “Great,” those very segments forget to mention that this was the era of peak union membership.

Unions mean better pay, richer benefits, and safer working conditions for their members. Unions give workers a way to voice their concerns, and advocate for their human rights. Comparatively, think about the noteworthy corporations, public and private, of our present day: what would Uber be if its drivers were unionized? How about Walmart? Or Facebook? How would all of our lives change if these workers were able to advocate for their own rights? Perhaps more interestingly, how *wouldn't* our lives change? If all Walmart workers were paid a living wage, would we really notice the difference?

Walmart is a fascinating example here: had the company not announced stock buybacks<sup>7</sup> in the wake of the Trump tax cuts (buybacks, of course, benefitting their shareholders), Walmart could have used the same amount of capital to raise their wages by \$5.66 an hour to \$16.66. A union probably would have *insisted* on such a measure, and since Walmart is the United States' largest employer, that wage increase would have positively impacted millions of lives.



*The automation era will require its own union, of sorts—what we're calling a “union of humans.”*



### *Unions in the Age of Robots*

Walmart’s future plans are grimmer for the union majority than its present state: America’s biggest employer is emphasizing contract workers from startups like Handy (more on “contract work” or “fissured work” in a moment) and more self-checkouts.<sup>8</sup>

This is why the automation era will require its own union, of sorts—what we’re calling a “union of humans.”

As computers’ skills increase, humans’ collective strengths and limitations will become increasingly apparent. We will all be forced to rethink our careers, and in times of such extreme, exponential change, exceptionalism will become untenable. As lawyers’ professions automate as quickly as cashiers’ and taxi drivers’, we will be forced to work together. A union of humans—and the labor-saving technology that we regulate—will likely usher in the greatest era of human existence.



Figure 03

Source: Galloway, Scott. *The Four: The Hidden DNA of Amazon, Apple, Facebook, and Google*. New York, Penguin, 2018.

Economists have been foretelling of this automation era since the ages of Adam Smith and Karl Marx. In 1930, the famed economist John Maynard Keynes believed that his grandchildren would inherit a world that was so gloriously automated, they'd only have to work for a few hours a week.<sup>9</sup>

Keynes wrote:

*“ Thus for the first time since his creation man will be faced with his real, his permanent problem – how to use his freedom from pressing economic cares, how to occupy the leisure, which science and compound interest will have won for him, to live wisely and agreeably and well.*

*The strenuous purposeful money-makers may carry all of us along with them into the lap of economic abundance. But it will be those peoples, who can keep alive, and cultivate into a fuller perfection, the art of life itself and do not sell themselves for the means of life, who will be able to enjoy the abundance when it comes.*

*Yet there is no country and no people, I think, who can look forward to the age of leisure and of abundance without a dread. For we have been trained too long to strive and not to enjoy. It is a fearful problem for the ordinary person... ”*

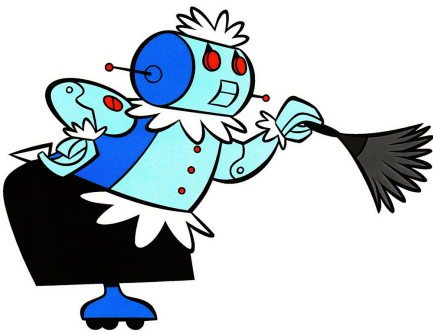

In the 1960s, The Jetsons' George Jetson even complained about being forced to work “two full hours” in a given day. (His wife Jane's response: “What does Spacely think he's running? A sweatshop?!”)

Millennials' reverence for the union could yield wonderful things in their future—and just in time, before automation becomes the scourge of low-skilled employment.

## I.01—Even the Millennial-centric publication VICE has unionized.



Image 01

Source: VICE Union

### *The Glory of a Union of Humans*

There is a version of our collective future wherein we work less and do more. There is a version of our future where corporations are taxed for the privilege of using robots to replace human beings. (That's Bill Gates' idea, by the way.)<sup>10</sup> In this new and better world, we can create jobs that are meaningful, rewarding and well-protected by the law. We can waste fewer resources of every variety: from our time to our material goods to our natural splendor. We need to hold CEOs and politicians accountable to get this future—and we need to start ruining their careers if they continually lie to us, just as Ida Tarbell did to John D. Rockefeller, when her essays in *McClure's* magazine lead to the breakup of the Standard Oil monopoly.



*We need to hold CEOs and politicians accountable.*

I.02—“They had never played fair,” Tarbell said of Standard Oil, “and that ruined their greatness for me.”

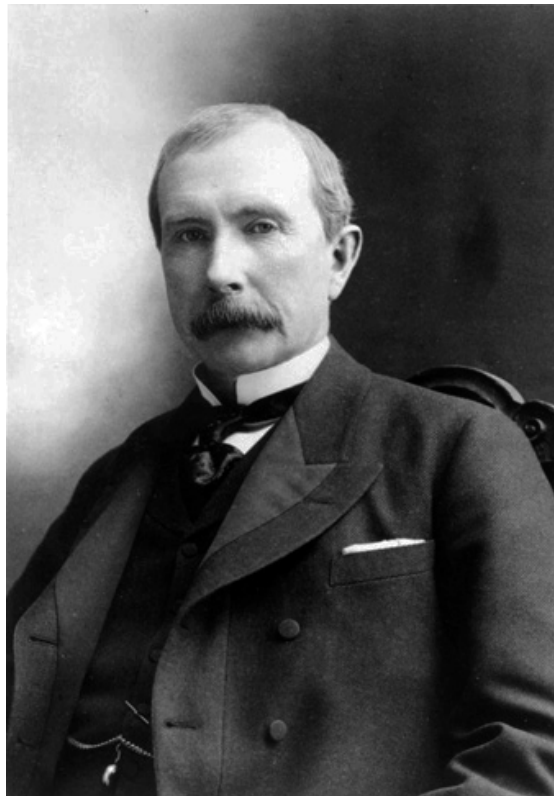

Image 02

Source: *Ida M. Tarbell, 1904. Library of Congress.*

Source: *John D. Rockefeller, 1885, The Rockefeller Archive Center.*

*In Summary: Here's What We Predict*

As Millennials approach middle age, Amazon and Alphabet will truly alter the structure of the economy, via—at the very least—substantial plays in healthcare and autonomous transportation, respectively.

Automation's effects will alter politics by fighting for social issues like single payer healthcare, guaranteed jobs, affordable housing, and a greater degree of federally-ensured social security. The harsh realities of American economics will force Millennials' hand: the politics of the future involve more progressive agenda items.

These shifts are predictable simply because they are inevitable: mired in debt and facing an increasingly automated economy, Millennials lack a future with increased social security. Without full employment, capitalism requires increased taxation.

In keeping with this shift, the young people in America will become more thoughtful, purposeful and progressive. They'll value human empathy as a needed counter to automated technology. They'll expect companies to be aware of—and concerned for—the health of the planet around them.



One last note: America's need for a bigger, broader social safety net could be addressed by the Democratic or Republican parties. (FDR, a rich kid who grew up on private estates whilst idolizing his older Republican cousin, Teddy, was the president who ushered in many of America's most socialist policies, and probably *not* the textbook socialist figure.) Whether or not these policies are wrapped in terms like "libertarian" or "socialism" (and Universal Basic Income has been called both) doesn't matter.<sup>11</sup> **What matters is that we end the extreme wealth concentration, and create broader opportunities for the many.**

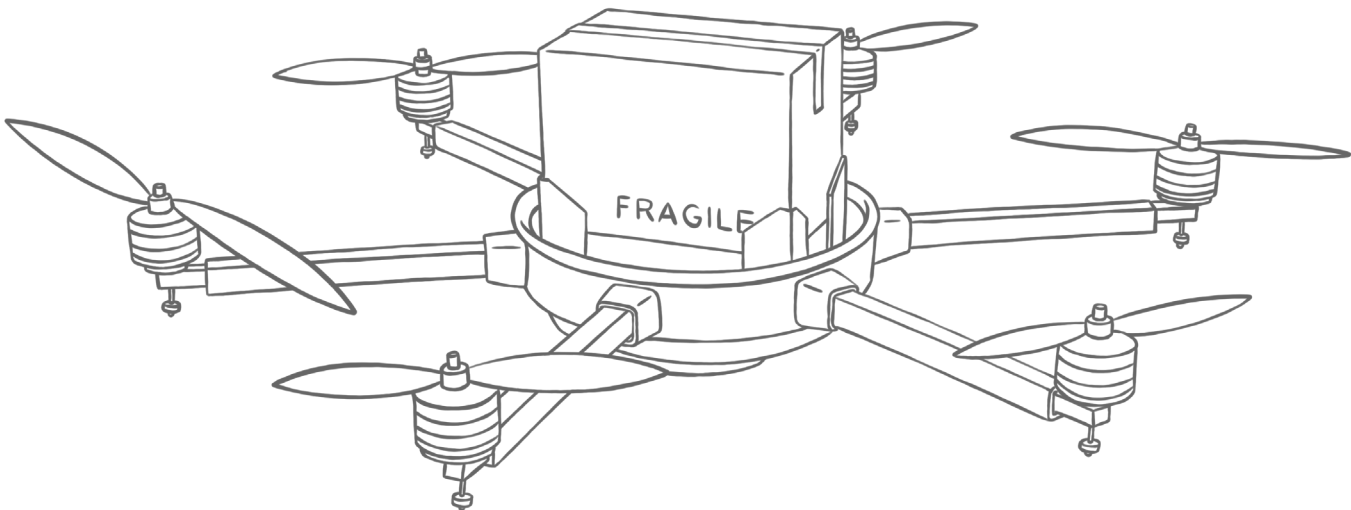

# States of the American Millennial: 2019

Before we delve into American Millennials' collective future, let's kick off with some rather-surprising facts:<sup>12</sup>

- 1** A child's chance of earning more than her or his parents has plummeted from 90% to 50%.
- 2** Earnings by the top 1% of Americans have nearly tripled in the last four decades, while middle-class wages have been basically frozen, adjusting for inflation.
- 3** Nearly 20% of children in the US are now at risk of going hungry.
- 4** Among the 35 richest countries in the world, the US now has the highest infant mortality rate and the lowest life expectancy.
- 5** Self-inflicted deaths — from opioid use and other drug addictions — are at record highs.
- 6** Americans owe over \$1.48T in student loan debt, spread out among about 44MM borrowers (most of that debt is carried by Millennials; in 2012, a staggering 71% of students graduating from 4-year colleges had student loan debt).



- 7 63% of Millennials have less than \$1,000 in their savings accounts, and 43% have \$0.
- 8 20% of Millennials identify as LGBTQ.

Whenever we want to get annoyed at Millennials—whenever it seems like they have the worst ever case of Instagram-inflicted Peter Pan syndrome imagined—let’s recall the context of their existence. They are being tasked with reinventing a helluva lot of things: including but not limited to gender identity and the global economy. As the Millennial scholar Amy Johnson noted in her Wellesley sociology honors thesis on the topic:<sup>13</sup>

*“Changing social structures have made the process of becoming an adult in modern society very different from previously established pathways, and the alienating and anxiety-inducing character of modern social life due to the dilapidation of traditional structures and the rise of individualism has a unique effect on 21st century young people’s transition to adulthood. The Millennial generation is coming of age in an era that is distinctly de-traditionalized, individual, and technologically advanced, and as a result is presented with a specific set of challenges.”*

## F.04—How Life Has Changed for Americans Aged 25 to 34 From 1977 to 2016

Cost of Public 4-Year College \$

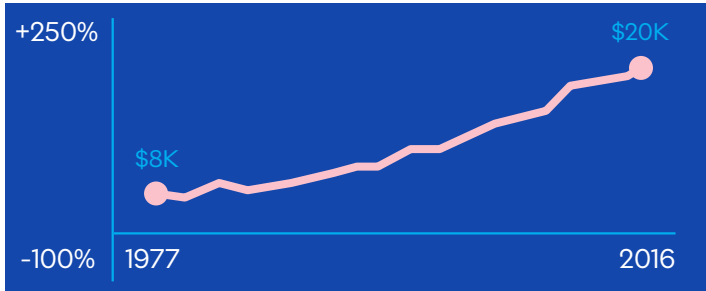

Median Income \$

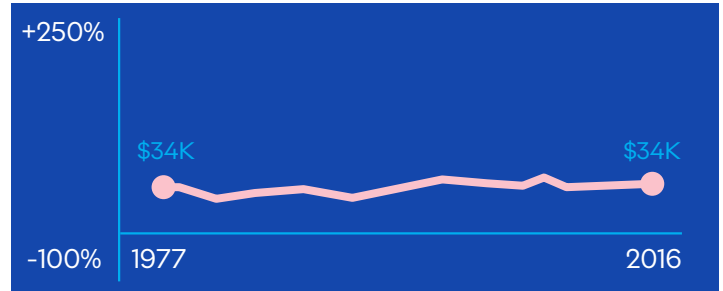

Median Debt \$

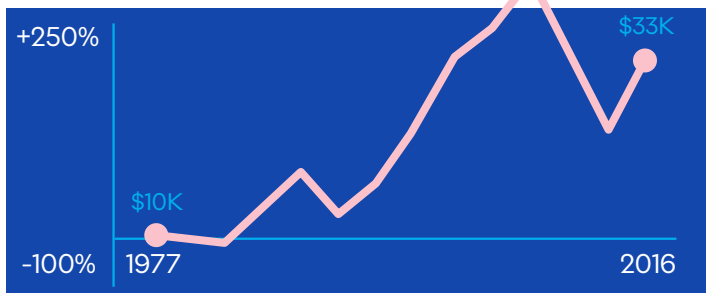

Attending 4+ Years of College %

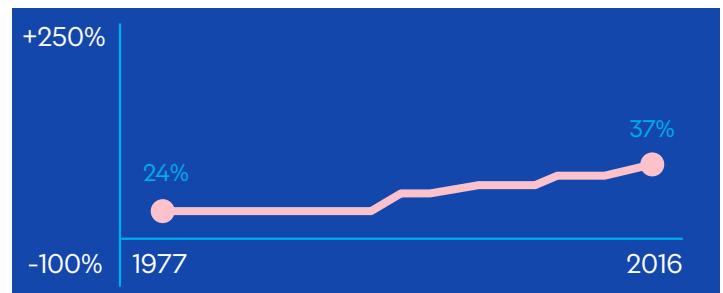

Never Married %

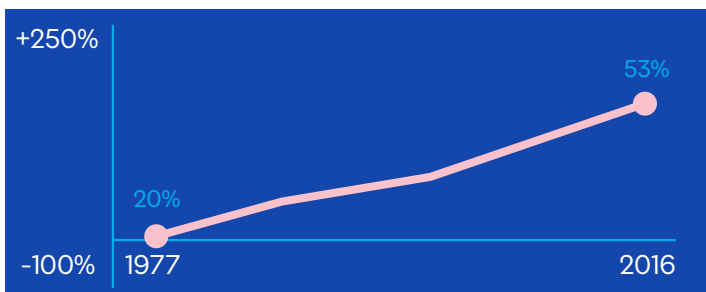

Homeowners %

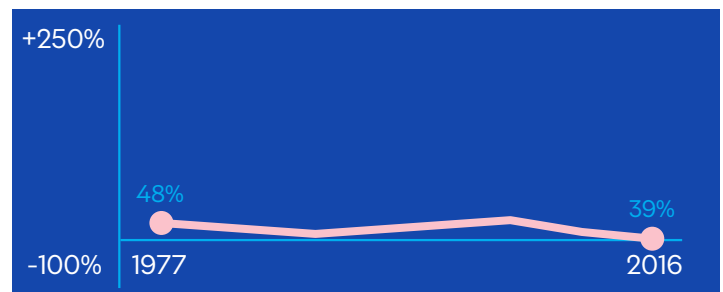
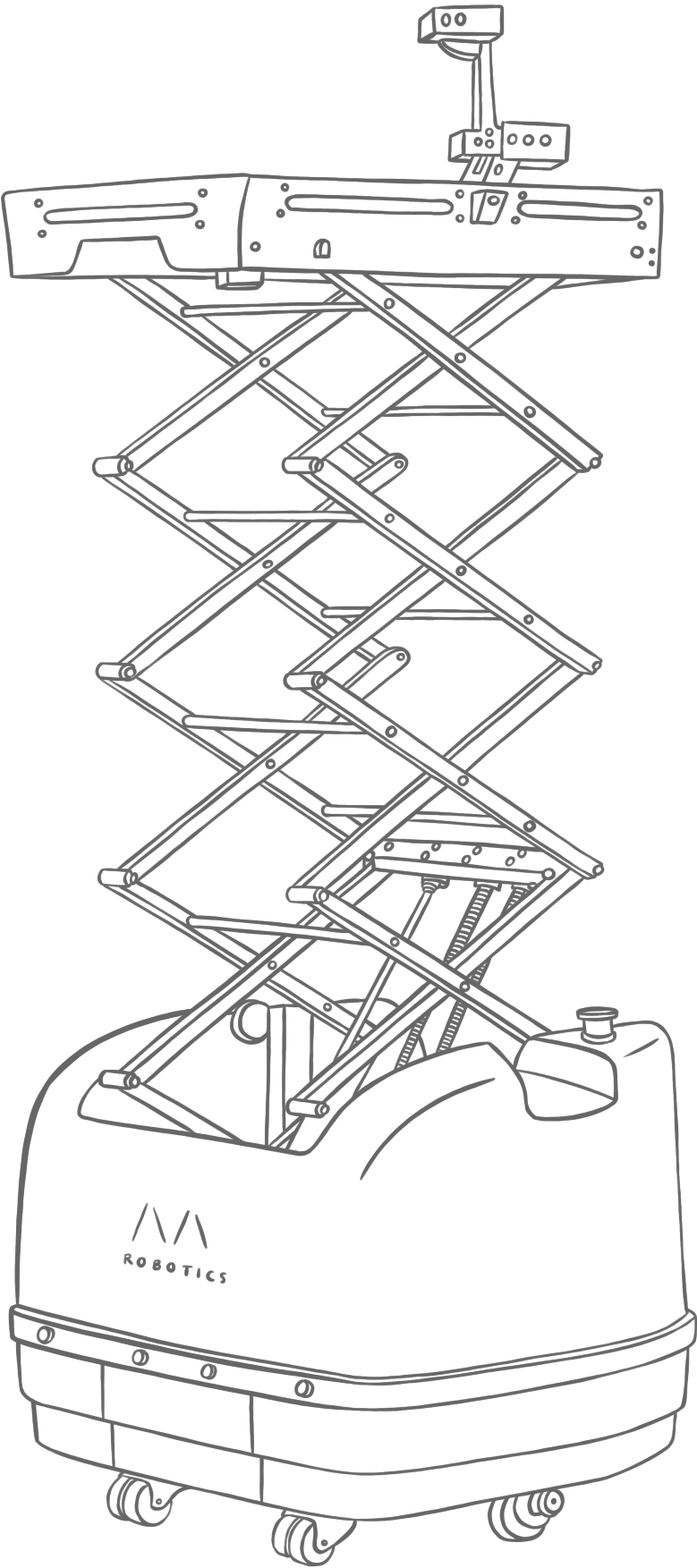

Figure 04

*Kight, Stef. "Being 30 Then and Now," Axios, July 22, 2018.*

*Chart: Harry Steven, Axios.*





01 PART I of III

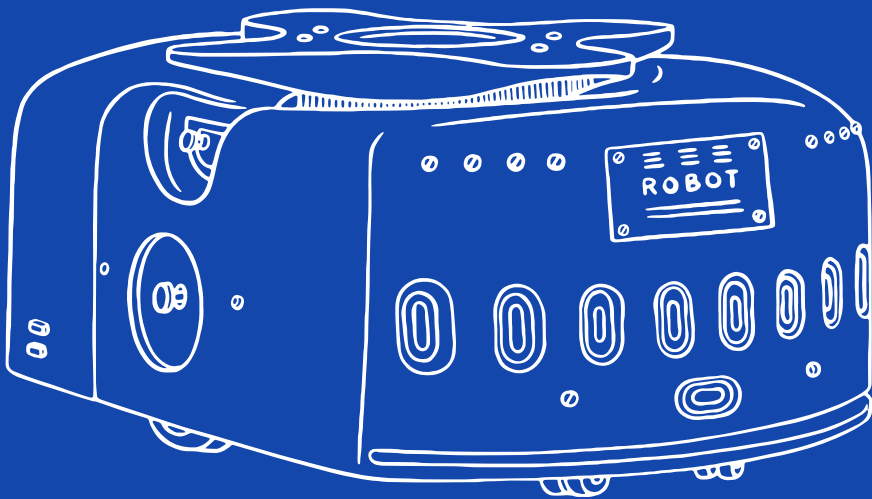

# Millennials & The Economy

*The Human Union*

## F.05—Percentage of Change in Stock Prices

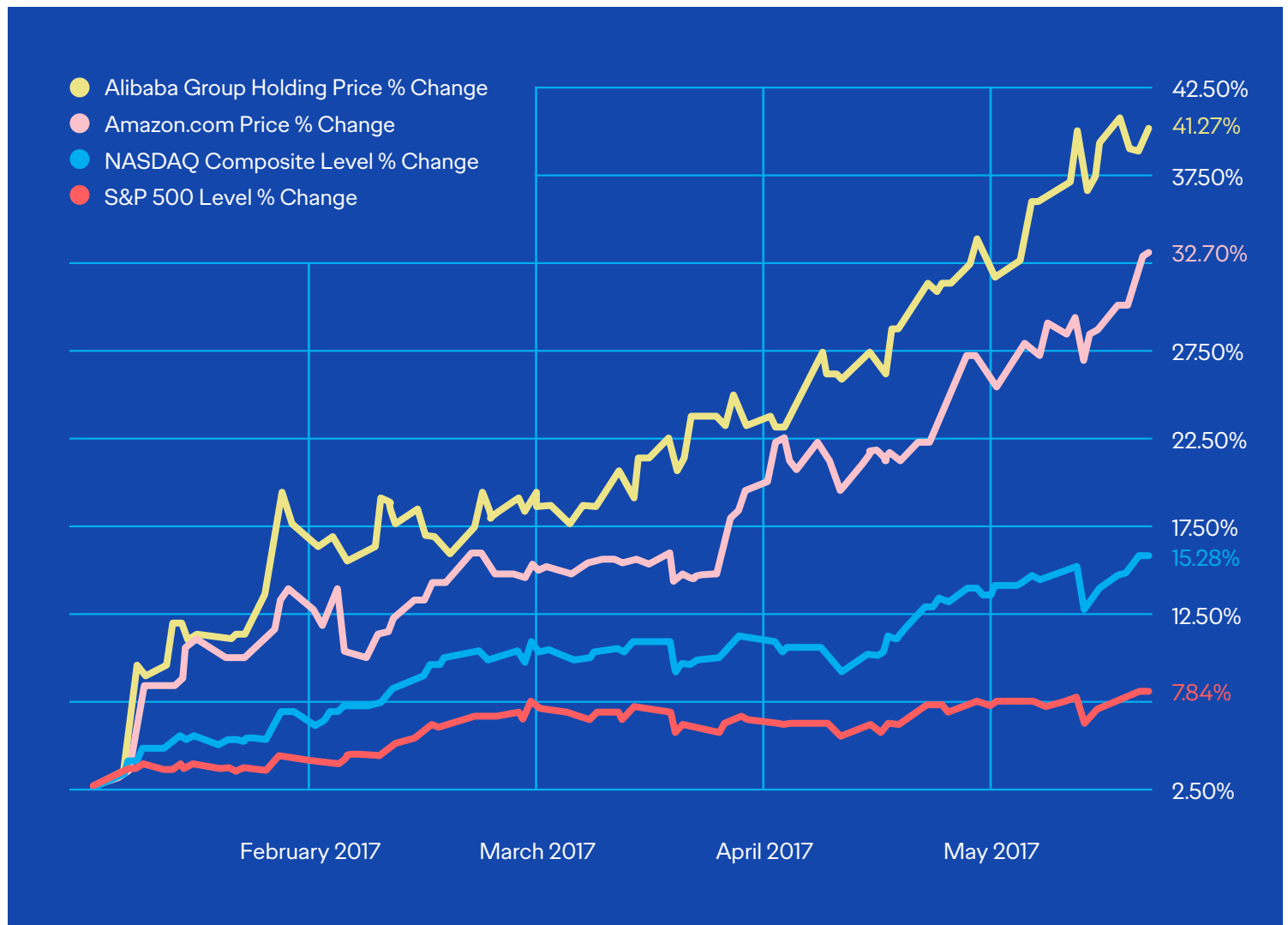

Figure 05  
Source: Y Charts.

## Millennials & The Economy

### *The Human Union*

In middle age, Millennials' defining economic issue will be how they react to truly unprecedented, industry-gobbling super-companies like Amazon, Apple, Alphabet and Facebook. **It's that serious, and that simple.**

*A Note for the Doubters:*

*Amazon is Unlike Anything Economists Have Ever Seen*

Companies used to grow linearly, but Amazon grows exponentially. Comparing Amazon with other companies is simply impossible. Irritatingly, the terminology we often use for both super-companies and super normal companies is often the same (market cap, revenue, profit, etc.), despite the capabilities and the goals are completely different.

*Imagine if we called an Hermes purse and a Ziplock bag both “bags,” with no further descriptors!*

## Old Way of Growing

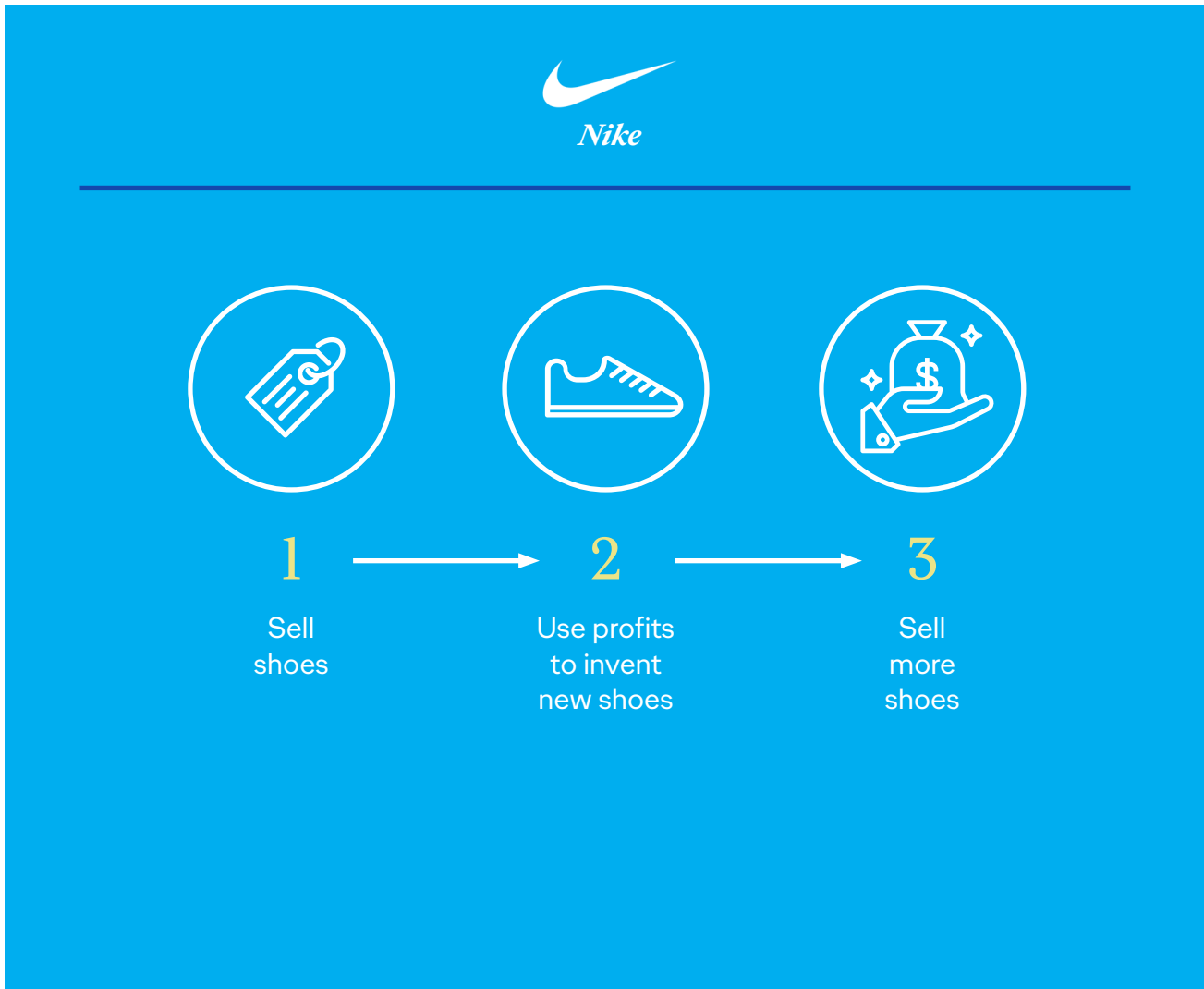

Aside from the sheer scale of its successes and goals, Amazon's ability to derive revenue from across what feels increasingly like the entirety of the economy is another facet of what makes them different from any competition: sure, Nike can compete with Amazon in the shoe business, but Nike will only ever have the profits to invest in new shoes that it made from selling...shoes.



## New Way of Growing

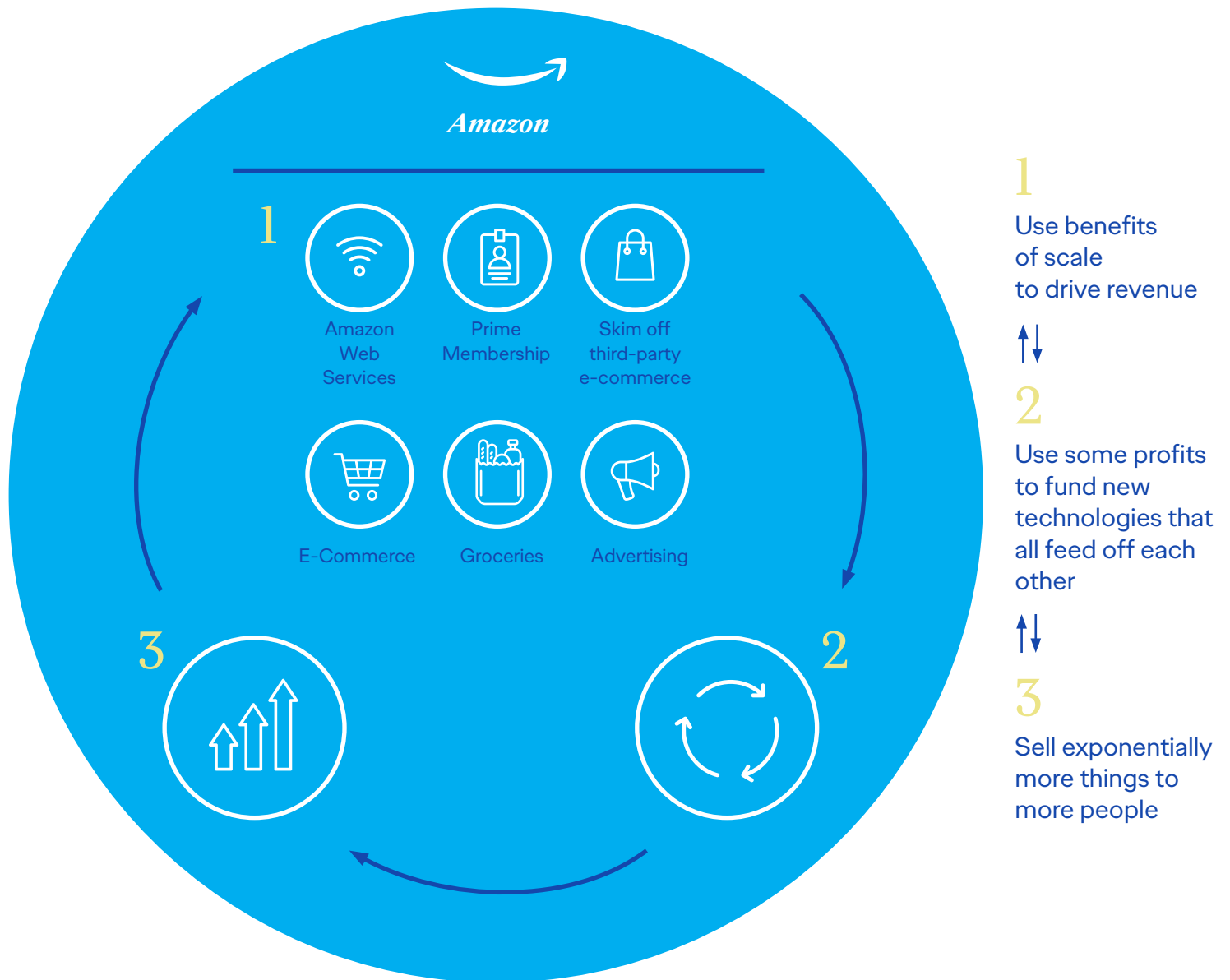

That's a very set amount of potential profit; the world only needs so many shoes in a year. Amazon, on the other hand, can choose to invest in shoes with the profits its garnered from dozens of different industries, plus the self-serving network effect of many investments benefitting other Amazon investments. (For example, if Amazon builds a UPS competitor, it not only damages UPS, it also damages Nike, because that investment helps Amazon sell more shoes.)

This nuance is lost on many Amazon doubters, but it is not lost on Mr. Bezos...

*“ When we win a Golden Globe, it helps us sell more shoes. And it does that in a very direct way. Because if you look at Prime members, they buy more on Amazon than non-Prime members, and one of the reasons they do that is once they pay their annual fee, they’re looking around to see, ‘How can I get more value out of the program?’ And so they look across more categories – they shop more. A lot of their behaviors change in ways that are very attractive to us as a business. And the customers utilize more of our services. ”*

JEFF BEZOS, 2016

A last staggering point to wrap your head around: the Amazon that we know today still has a ton of room to grow. **Amazon only represents around 1% of total global commerce.** As we’ll discuss in a later section of this report, though 50% of all American households are Prime members (meaning they’re paying an annual \$119 fee for the privilege of having a front row seat while Amazon expands indefinitely, consolidating all of our life’s purchases), 50% are not. That’s a big potential customer base.

Prime has yet to spread its wings in other corners of the world, as well: in other words, simply by expanding the footprint of Amazon’s existing technologies, there are massive markets from which Amazon could derive scale and growth in the coming quarters and years. As of now, Amazon’s biggest focus is on India, with about \$5B committed to Amazon-ing their daily lives.

## *The New, Global Battle for Tech Domination: “Fangs vs. Bats”*

**F.06—The Big Three: “BAT” vs. “FANG”**

		<i>Market Cap</i>	<i>2016 Revenue</i>
B	Bai Du	\$82 Billion	\$10 Billion
A	Alibaba Group	\$449 Billion	\$23 Billion (\$68B in GMV)
T	Tencent	\$407 Billion	\$19.5 Billion
F	Facebook	\$497 Billion	\$28 Billion
A	Amazon	\$476 Billion	\$135 Billion
N	Netflix	\$79 Billion	\$8 Billion
G	Google	\$646 Billion	\$90 Billion

Figure 06

Source: Tung, Hans. “Lessons from China for Global Entrepreneurs,” GGV Capital, October 2017.

In China and the United States, a short list of absolutely massive technology companies are gobbling up industries, eliminating middlemen, building unprecedented efficiencies, thus reorganizing businesses and governments alike. In total, this short list of companies’ combined market capitalization tops \$4 trillion, and they will shape much (if not most) of the Millennial economic landscape into the 2020s and beyond.

I.03 — “Chinese tech isn’t an imitation of its American counterpart. It’s a completely different universe,” says Wang.

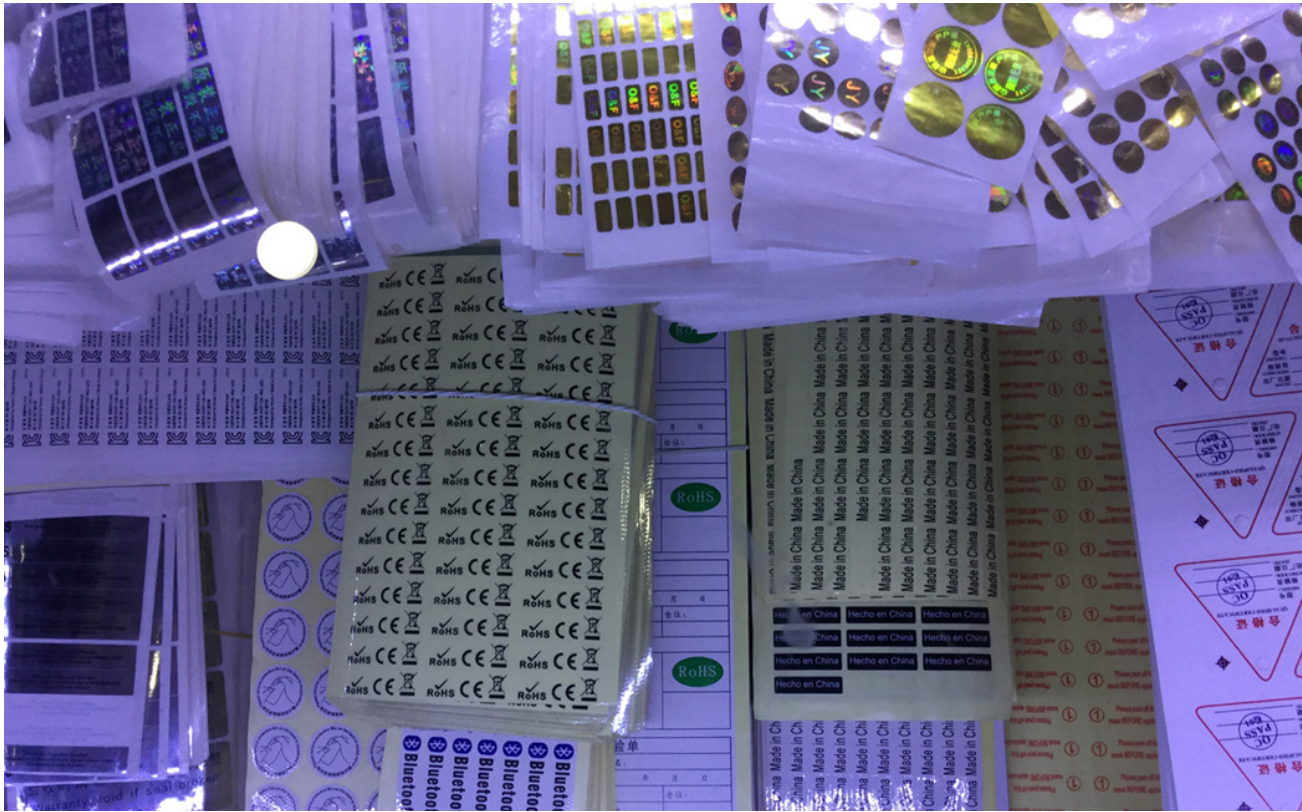

Image 03

Source: *Made in China stickers*. Photo from Xiaowei R. Wang, “Letter from Shenzhen,” *Logic*.

At some point, the Chinese technology companies will come into more direct competition with the American technology companies. For the time being, each market is relatively separated, and each market still leaves much room for growth.

We won’t have time to go deep in this report, but the technology Alibaba, JD, Baidu and Tencent have created for the Chinese market is absolutely incredible. Perhaps most impressively, unlike in the United States, where much of the Midwest lives outside the range of Amazon’s most immediate services, like Prime Now same day delivery, China’s rural markets are well-served by BAT-J’s technology.

In a beautiful piece about the capability and ubiquity of WeChat (the Facebook/PayPal/SoFi of China, built by Tencent), writer Xiaowei R. Wang says, “I use WeChat to message a friend while standing in the middle of a rice paddy, to pay for snacks and water in a remote village, to buy train tickets, to book hotel rooms, to order taxis, to get takeout, and to send my aunt photos. If I wanted to, I could also use it to pay electricity bills, top up my mobile phone account, make hospital appointments, and check the weather.” He goes on to say:

*“When I get back to San Francisco, I joke with people that I have not traveled in China – I have time-traveled. Shenzhen to Guangzhou takes a mere thirty minutes on the high-speed train that runs at 186 miles per hour. Through the turnstiles, a passport reader scans your ID and ticket, displaying your face on a screen. A green box appears, using facial recognition to signal that you are allowed to pass.”*

XIAOWEI R. WANG<sup>14</sup>

Though back in the U.S. Facebook has flailed a bit this summer, it’s easy to envision a more WeChat-like future, with better embedded payments, more storefront features or partnerships, and more focus on rural areas instead of urban ones. In China, Alibaba goes so far as to train villagers on how to use its small business tools. Facebook will take note: FANG is often learning from BAT, with Facebook especially attuned to the moves of WeChat in particular. (There’s a reason why Mark Zuckerberg’s Mandarin is getting really good.)

## *If All This FANG & BAT Stuff is Happening, Why Aren't We Talking About It?*

Much as the “automation” narrative didn’t exist a few years back, the “Holy moly, what the heck is Amazon doing to capitalism and the wage-based employment model, it’s sort of destroying it...” narrative is still a few moments from the mainstream, as well.

Soon the big newspaper think pieces and incessant television coverage will gear up, and we’ll finally begin to have this much-needed debate in public. Millennials will use this moment to begin the Universal Basic Income conversation—a concept that enjoys wide political support across all parties—and the real change will begin. It’s all incredibly exciting, though there’s always an advantage to thinking about things first.

Why so quiet for so long—why isn’t everyone in America talking about FANG and BAT like they’re Fannie and Freddie? Per *The Economist* in July:<sup>15</sup>

“*[The] reason for the battle’s low profile is that it is not being fought in the open. The American firms have, broadly, transplanted their services to other markets; Amazon has pledged over \$5bn to replicate its offerings in India, for example. But the Chinese giants are taking a different tack, buying stakes in local firms and weaving them together into complex tapestries of services. The ecosystem of Tencent and Alibaba, with over 1,000 stakes in foreign firms, includes dozens in emerging markets. Along with Ant, they have backed 43% of all Asian unicorns, startups worth more than \$1bn. Chinese tech firms pumped \$5bn into Indian startups in 2017, a fivefold increase on the year before. America’s tech giants are wearing uniforms abroad; China’s melt into the background.*”





Image 04

Source: Photo by Jason Doiy from Wired Magazine.

In America, Facebook, Alphabet, Apple and Netflix are massively powerful: they're industry-gobbling behemoths. Facebook will continue its reign as an advertising company supreme, Netflix will haunt Hollywood, Apple will rule with secure hardware, and Alphabet will make a big play for, among things, the autonomous driving world, given that Waymo just clocked in at 8 million total autonomous miles driven, which dwarfs the traditional car company competition.<sup>16</sup>

In this report we're going to concentrate on Amazon—in part because there isn't space in this report to cover the other players, and also because Amazon can serve as an analog for the mind-bending things that are possible for a super-company in this age of exponential growth.



*A Mind-Bending Amazon Implication for the 2020s:  
Full Warehouse Automation is Already Possible*



Image 05

*JD Distribution Center in China: 4 humans required, 200,000 packages shipped per day. Source: Yicai Global.*

One staggering implication for the Millennial economy? “Full warehouse automation” is not an exaggeration, it’s already the reality in China: where JD opened up a warehouse at Kunshan, outside Shanghai, where the robots can complete all the labor. The 4 jobs allotted to humans? Fixing the robots.<sup>17</sup>

(In many parts of China, frictionless, employee-less shopping is totally normal. WeChat, Tencent’s Facebook equivalent, is so sophisticated it can grant a user a mortgage or a loan in seconds—or a bus pass. Expect much of the same to become the standard here.)



## F.06—Who Does What, US and China?

<i>Core Business</i>	<i>Ex-China / FANG</i>	<i>China / BATJ</i>
Social Networking Service	Facebook   FB	Tencent   TCEHY
E-Commerce	Amazon   AMZN	Alibaba   BABA, JD.com   JD
Streaming Video	Netflix   NFLX	*
Search, Maps, AI	Google/Alphabet   GOOG	Baidu   BIDU

*\* Baidu's iQiyi and Alibaba's Youku Tudou are leaders in China's streaming video business. In April 2017, Netflix announced a licensing agreement with iQiyi to gain access to China.*

Figure 06

Source: Sakazaki, Lloyd. "Attractive Relative Value in Chinese 'BATJ' vs. US-Based 'FANG' Stocks," Lloyd's Investment Blog, May 3, 2017.

As of right now, these Chinese companies are largely quarantined by differing infrastructure and language. Within the Millennial lifetime, that situation will change, and China's super-companies will increasingly compete with—or, perhaps, partner with?!—America's super-companies.

Recall from the earlier pages of this report that Walmart is our nation's biggest employer, and 10% of Americans currently work retail jobs (the industry is second only to healthcare).<sup>18</sup> When warehouses and stores automate, all of our communities and families will be affected. How many of us worked a retail job at some point in our careers? Waited tables or tended bar to pay for college? What would we have done if there wasn't the retail sector to turn toward?

## F.07—Three Organizational Forms Resulting in Fissured Workplaces (*Selected Examples in Italics*)

Industry	Lead Business	First Tier	Second Tier	Third Tier	Fourth Tier
<i>Subcontractor Model</i>					
Coal Mining	Mine Controlling Business <i>Massey Energy</i>	Mine Operators <i>Performance Coal Co.</i>	Contract Operators <i>Black Diamond Construction, Inc.</i>		
Cellular Phones	Cell Phone Carriers <i>AT&amp;T</i>	Turfing Managers <i>Nsoro</i>	Lead Subcontractor <i>WesTower</i>	Second-Level Subcontractor <i>ALT Inc.</i>	Third-Level Subcontractor
Logistics & Operations	Retailer or Manufacturer <i>Walmart, Hershey</i>	Logistics Provider <i>Schneider Logistics</i>	Temporary Help Company <i>PWV</i>	Second-Level Temp Agency <i>Rogers-Premier</i>	
Cable Services	Media Provider <i>Time Warner</i>	Regional Cable Turfer <i>Cascom</i>	Installers as Independent Contractors		
<i>Franchise Model</i>					
Fast Food	Franchisor <i>KFC, Pizza Hut</i>	Franchisee <i>Morgan's Foods Inc.</i>	Labor Contractor		
Janitorial & Building Services	Lead Company in Variety of Sectors	Franchisor <i>Coverall</i>	Regional Franchisee	Local Franchisee	Labor Contractor
Hotels (Hybrid Model)	Hotel/Motel Brands <i>Marriott</i>	Franchisee/Owner <i>Host Hotels &amp; Resorts</i>	Brand or Independent Operating Co. <i>Crestline Hotels &amp; Resorts</i>	Labor Staffing Company <i>Hospitality Staffing Solutions</i>	Subcontracted Landscaping or Janitorial Service
<i>Supply Chain Model</i>					
Apparel	Manufacturer or Retailer <i>Forever 21</i>	Contract Manufacturer/Subcontractor <i>CMR Clothing Inc.</i>	Second-Tier Contractor <i>CUI Sewing Inc.</i>	Third-Tier Contractor	
Food Industry	Food Processor	Growers	Farm Labor Contractors	Farm Workers as Independent Contractors (prior to 1987)	
Computer Industry	Computer Brand <i>Apple</i>	Contract Manufacturer <i>Foxcomm</i>	Subcontractors	Sub-Subcontractor	

*In an Era of Partial and Full Automation,  
It's Fissured Work—Not Freelance Work—That Really Matters*

*“Every day, many of us eat at restaurants, stay at hotels, receive packages, and use our digital devices with the assumption that the company we pay for these services — Hilton, Amazon, Apple, etc. — also employs the people who deliver them. This assumption is increasingly incorrect: Our deliveries are often made by contractors and our hotel rooms are cleaned by temporary employees from staffing agencies.”*

DAVID WEIL, Author of “The Fissured Workplace,” Harvard University Press

Head of the Department of Labor’s Wage and Hour Division, Obama Administration

In the absence of unions, the “third party employer” has crept in and become an unfortunate labor norm.

Many white collar workers would like to believe that their jobs could not be outsourced to a third party employer, but Weil says this thinking is dead wrong. Fissured employment is appealing to any company that has to report quarterly growth, says Weil, because it’s ruthlessly cost efficient. (And ‘ruthless’ is the key idea there—fissured work prioritizes a company’s bottom line above the well-being of its employees.)

Automation will only increase fissured work’s appeal, as it will make it easier to lay off swathes of workers when technology can replace their labor.

Figure 07

Source: Weil, David. *The Fissured Workplace*. Harvard University Press, Reprint Edition, 2017.

## I.06—McDonald's workers went on strike to protest sexual harassment, and attempted to organize.



Image 06

Source: NBC News.

## *The Other Problem with Fissured Work: Worker Safety*

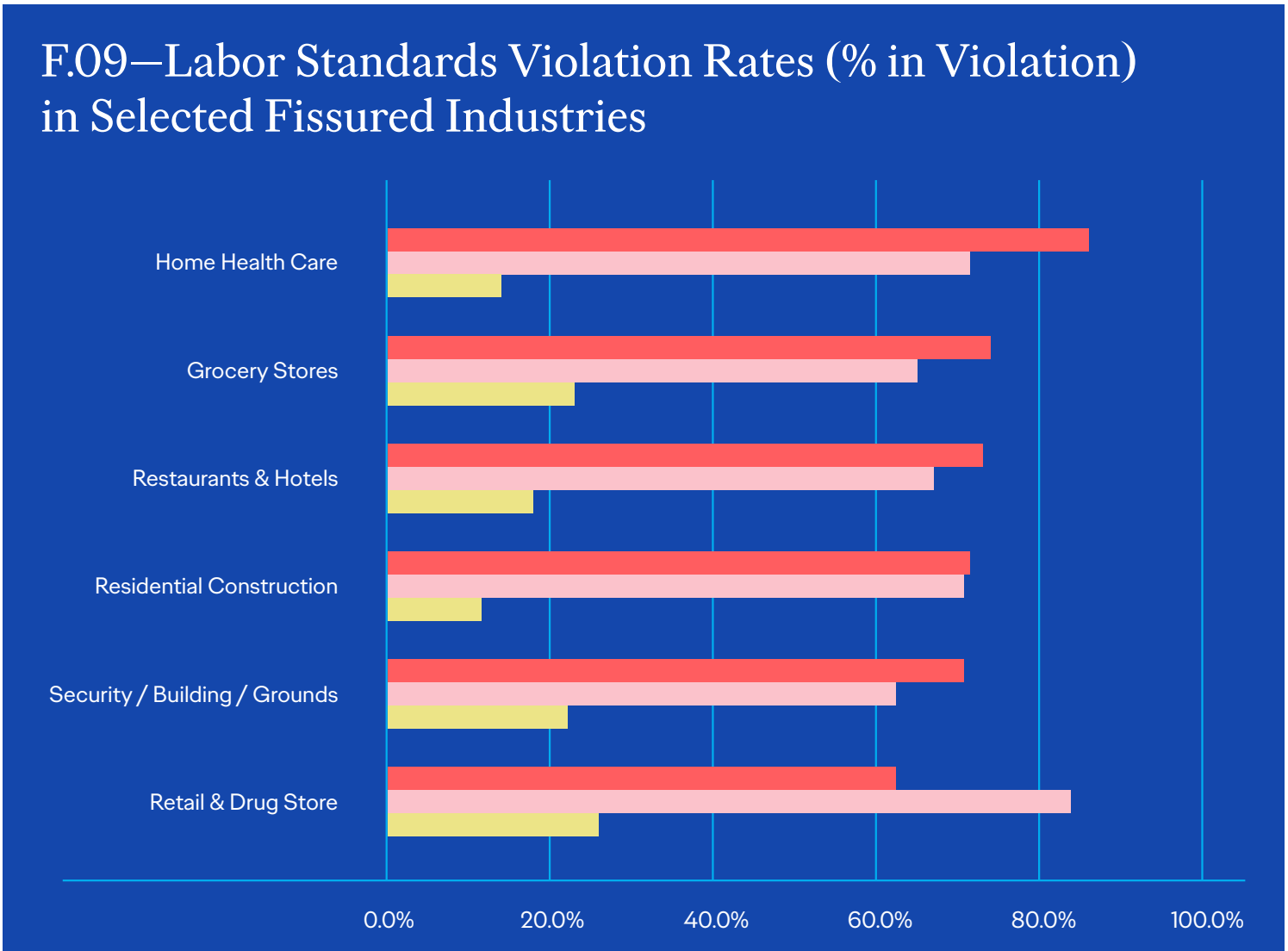

Figure 09

Source: *Researchgate.net*

● Off the Clock    ● Overtime    ● Minimum Wage

Fissured employment (a.k.a. doling it out to someone else for a fee, so that it's not your legal and logistical headache) creates a perfect Petri dish for unsafe working conditions. Workers, struggling to point fingers at their indirect employer (the logo on their shirt) and their direct employer (the company contracted out to employ them, vis-a-vis the logo on the shirt) often struggle to try cases in instances where violations are taken to court.



## F.10—Change in Complaint Rates

### *Fair Labor Standards Act 2007-2009 vs. 2001-2002*

### *Ranked by 2007-2009 Employment*

Industry	2007-2009 Total Employment <i>Average</i>	2007-2009 Complaint Rate <i>Cases/Employee</i> x 100,000	2001-2002 Complaint Rate <i>Cases/Employee</i> x 100,000	% Change 2001-2002 to 2007-2009
<b>Total/Weighted Average <i>Whole Economy</i></b>	<b>111,175,322</b>	<b>15.6</b>	<b>21.1</b>	<b>-26.4</b>
Retail - All	15,120,711	13.7	20.5	-33.2
Health Care Services <i>Does Not Include State Hospitals</i>	13,196,814	11.6	16.3	-28.9
Retail <i>Mass Merchants, Department Stores, Specialty Stores</i>	9,315,599	10.2	16.2	-37.1
Restaurants Limited & Full Service	7,968,326	30.4	35.2	-13.5
Construction	6,879,048	26.2	30.7	-14.8
Grocery Stores	2,484,572	10.2	15.0	-32.2
Gasoline Stations & Auto Repair	1,687,929	42.3	52.5	-19.4
Hotel & Motel	1,459,546	37.9	47.0	-19.4
Recreation	1,418,641	14.7	19.8	-26.0
Trucking	1,364,638	48.4	54.4	-11.0
Agriculture	1,159,168	13.7	16.0	-14.4
Moving Companies & Logistics Providers	1,017,273	9.0	14.3	-37.0
Home Health Care	966,772	14.7	21.3	-31.0
Janitorial Services	934,009	39.6	42.7	-7.2
Residential Construction	796,325	47.6	24.3	95.5
Landscaping Services	647,415	20.7	27.3	-23.9
Nail, Barber, & Beauty Shops	490,139	16.7	13.9	20.2
Apparel Manufacturing	193,367	44.1	35.7	23.5
Car Washes	140,657	44.3	45.3	-2.1

Figure 09

Source: Weil, David. *The Fissured Workplace*. Harvard University Press, Reprint Edition, 2017.

## *How Are Millennials Faring Thus Far?*

There are two sets of (very different) Millennial complaints echoing from the different ends of the current employment spectrum, which we'll call the “have-nots” and the “haves.”

### *The Have-Nots: Sh\*t Jobs*

At the less fortunate end of America's economic spectrum, lesser skilled workers are getting a raw deal because of fissured employment models. In a world where noblesse oblige has gone out of fashion—a world where big companies no longer pride themselves on taking good care of all their workers, and instead focus only on making life sweet for some of them—a lot of people are being left out in the cold, and many are understandably furious.

*Companies used to serve the greater good;  
now they serve shareholders.*

Indirect (or “fissured”) employment models are great for shareholders, which, in the absence of union power, is the greatest exogenous force on corporate senior leadership decision making.

Alphabet and Apple have both refused to report how many indirect employees work at their headquarters.<sup>19</sup> These workers (whom Alphabet calls “TVCs,” meaning “temps, vendors or contractors”) don't get stock benefits, or cushy perks, or a say in how their employers operate. As Alphabet expands into more geographies, it relies increasingly on these unofficial shadow workforces. How does it feel to be working in a free food wealth utopia, without access to the riches that surround you? Pretty isolating, humiliating and frustrating.

I.07—Google staffs its fancy cafeteria full of people it doesn't actually employ: a harsh choice for one of the most successful companies in history.



Image 07

Source: Erin Seigel, Reuters.



### *Sh\*t Job Creators, Beware: The Millennials Are Coming*

In the wake of Hillary Clinton’s presidential run, Millennials across the country and moving further left in their politics, advocating for ideas once considered “impossible” by even Obama admins, like single payer healthcare.<sup>20</sup> (The Democratic Socialists of America now boasts 40,000 members across the country, with a spike in membership after Alexandria Ocasio-Cortez’s stunning win.)<sup>21</sup> Progressive congressional candidates in states as diverse as New York, Pennsylvania, Missouri, Hawaii and Kansas are attracting national attention.

After her groundbreaking victory, Ocasio-Cortez traveled with Bernie Sanders to Kansas, where they spread the message on single payer healthcare and wealth redistribution. “You are carrying the candle of hope for this country,” she told her packed Midwest audience. Ocasio-Cortez believes that people-centric policies like single payer healthcare can thrive across the country, and not just on the coasts. Determined to make her vision reality, she’s supporting progressive candidates in a variety of states.

In her September 2018 book, *Heartland: A Memoir of Working Hard and Being Broke in the Richest Country on Earth*, author Sarah Smarsh demystifies the Trump mentality and reality to non-Trump voters. In a recent op-ed, she wrote, “Most struggling whites I know live lives of quiet desperation mad at their white bosses, not resentment of their co-workers or neighbors of color. My dad’s previous three bosses were all white men he loathed for abuses of privilege and people.”<sup>22</sup>

Smarsh agrees that Ocasio-Cortez's politics will thrive among Millennials in Kansas, or any other Trump-leaning state. Many Trump states are also states where Millennials turned out in droves for Bernie Sanders.

Millennials, having experienced blistering inequality and wealth concentration, will vote for politicians who reverse it. Now is a time for another FDR, and when she is old enough to run for President of the United States, Alexandria Ocasio-Cortez might be just that.

### *The Haves: Bullsh\*t Jobs*

Even the Millennials lucky enough to be at the top of the corporate food chain have their own complaints: they're burdened by a sense of helplessness amid a world attempting to save itself.

The best documentation of these concerns can be found in a new book by David Graeber called *Bullshit Jobs*. In the text, the famed anthropologist Graeber writes about the "hundreds of thousands" (his own research's estimate) of white collar workers who feel that their jobs are largely pointless.

Graeber's theory, as elucidated by an interview with *Vox*, is that "Technology has advanced to the point where most of the difficult, labor-intensive jobs can be performed by machines.<sup>23</sup> But instead of freeing ourselves from the suffocating 40-hour workweek, we've invented a whole universe of futile occupations that are professionally unsatisfying and spiritually empty."

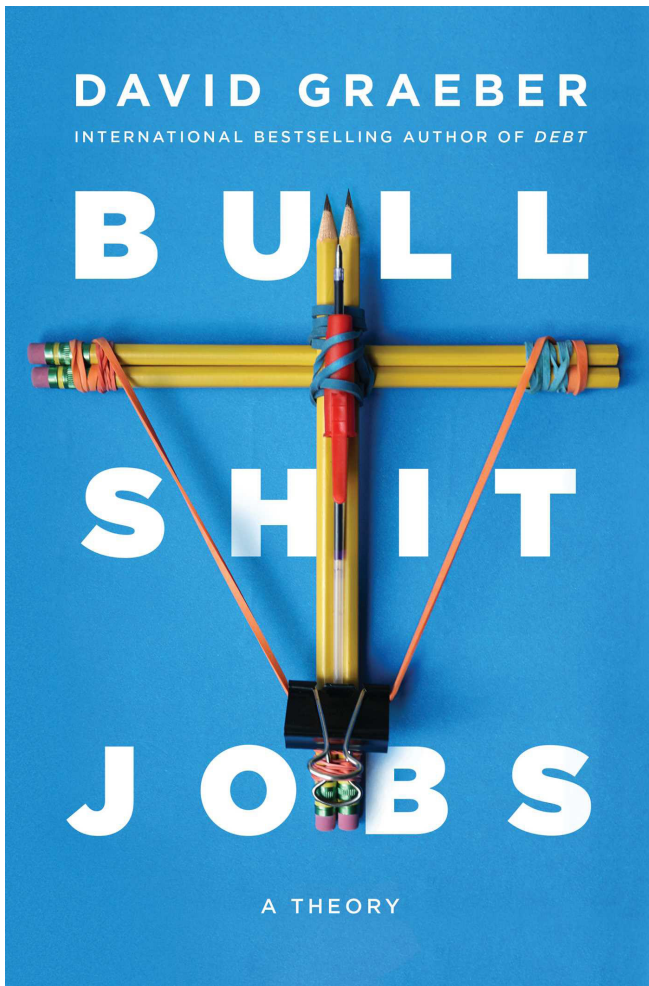

As Graeber explained to Vox's Sean Illing,

*“Bullshit jobs are jobs which even the person doing the job can't really justify the existence of, but they have to pretend that there's some reason for it to exist. That's the bullshit element. A lot of people confuse bullshit jobs and shit jobs, but they're not the same thing. Bad jobs are bad because they're hard or they have terrible conditions or the pay sucks, but often these jobs are very useful. In fact, in our society, often the more useful the work is, the less they pay you. Whereas bullshit jobs are often highly respected and pay well but are completely pointless, and the people doing them know this.”*



## I.08—Affluent Millennials are choosing financial safety above passion. But at what cost?



Image 08

*A scene from Black-ish. Source: Refinery29.*

In 2011, Yale student Marina Keegan wrote a much-lauded essay for the *Yale Daily News* about her classmates being recruited for hedge fund-like jobs regardless of their chosen major.<sup>24</sup> Interestingly, this recruiting process was working, and 25% of her peers were opting for the high pay of finance over pursuing their passions. Ms. Keegan memorably wondered why was Yale was sending so much of its talent into the depths of rentierism.

Ms. Keegan's conclusion was that the siren song of financial safety was, for her peers, too alluring to deny. After growing up in a life of comfort, pursuing that risky idea felt like too much. As she quoted a fellow student in her essay, "I'm trying to figure out if I love art enough to be poor." Of course, any student asking such a question in the first place likely doesn't have the intergenerational family pressure to contribute income to other people. In such a case, the option to pursue a life of artistic poverty doesn't exist.

Ms. Keegan's essay was nearly a decade ahead of its time: this was the question the most affluent of Gen Xers raised their children to wonder.

Consider the television show *Black-ish*. In the pilot episode, the series' patriarch describes his desire to do anything for his family's well-being. Later in the episode, we learn that this includes taking a promotion with racist, marginalizing tones (Dre is made the SVP of his company's brand new "Urban Division"). The jokes are plentiful. They encourage the question "At what price glory?"

## F.11—The Countries Most Dependent on Remittances *Remittance Inflows as a Percentage of GDP, 2013*

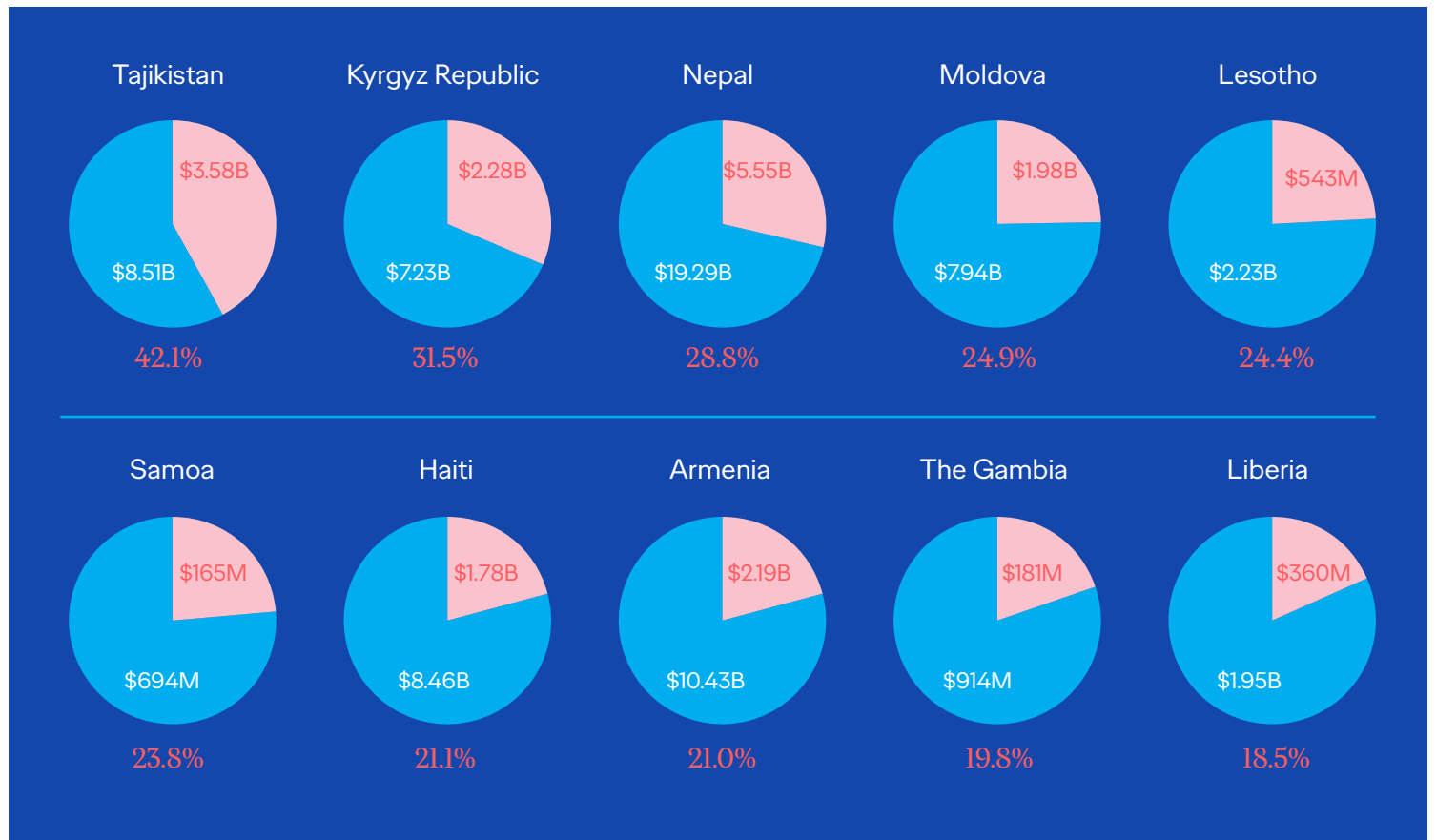

Figure 11  
Source: Mashable, Statista.

Total GDP ●  
Remittance Inflows ●

*The Remedy to the Bullsh\*t Job: The Give-a-Sh\*t Job***Millennials Will Eliminate Much of Economic Rentierism**

Many of Millennials' best and brightest additions to the economy have been business models, technologies and processes that eliminate bullshit jobs and replace them with wonderful, meaningful jobs.

Case in point: Circle's encroachment on Western Union's territory.

Remittances, or money sent to friends and family in other countries for the purpose of assistance and not profit, are one of the most powerful and effective ways to help people out of poverty. Nearly \$500B in remittances are sent every year,<sup>25</sup> which is 3x as much as all the foreign aid doled out by governments.

For decades, Western Union has enabled these remittances—while charging a hefty average fee of over 7%. Additionally, the receiving friends/family members have to walk to a Western Union, sometimes for miles, to receive the money.

Along came Circle, the blockchain-based exchange platform. CEO Jeremy Allaire has said, "In 5 years or 10 years, the whole idea of a remittance or cross-border payments will be gone, just like we don't have cross-border email, or cross-border web browsing. It's just the internet."

The economic term for a person or company living off the income from property or securities is a rentier. Rentiers often charge high fees simply because they can. The economist John Maynard Keynes predicted, and ultimately called for, the “euthanasia of the rentier.” He felt that such middlemen did not contribute to society as they didn’t produce anything of value, like an object or an idea. They simply charged fees.

Millennial-centric companies like Circle are doing just that: they’re freeing up that 7%+ of \$500B (That’s \$35B!) of hard-earned aid for family and friends, and sending it via secure new technology protocols, instead of trapping it in a needlessly inefficient system where shareholders skim off the transactions without providing any real value.

 *Now that is meaningful employment.*



*In Summary...*

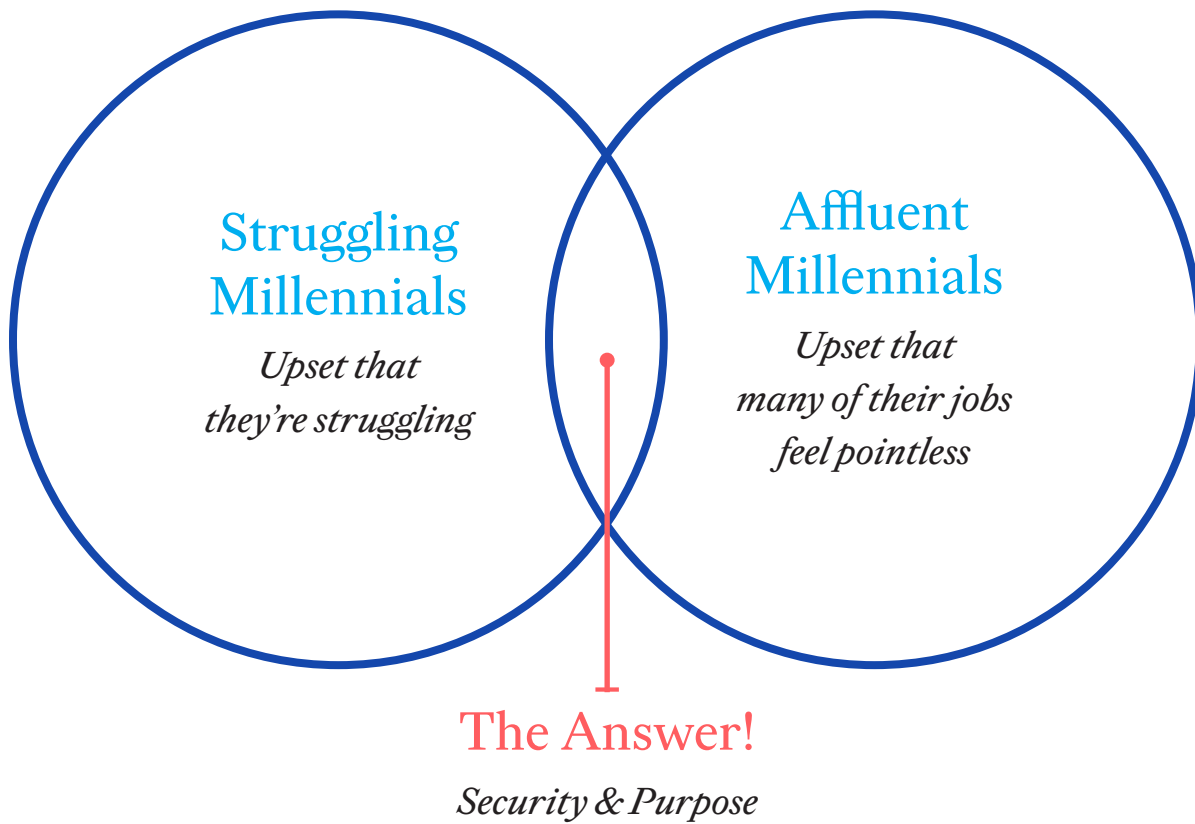

## OKay, Let's Get Into Amazon...

### *Millennials' Future: The Amazon Economy*

F.12—Amazon's Unprecedented Growth  
*Net Sales in Billions, 2013 - 2017 Fiscal Years*

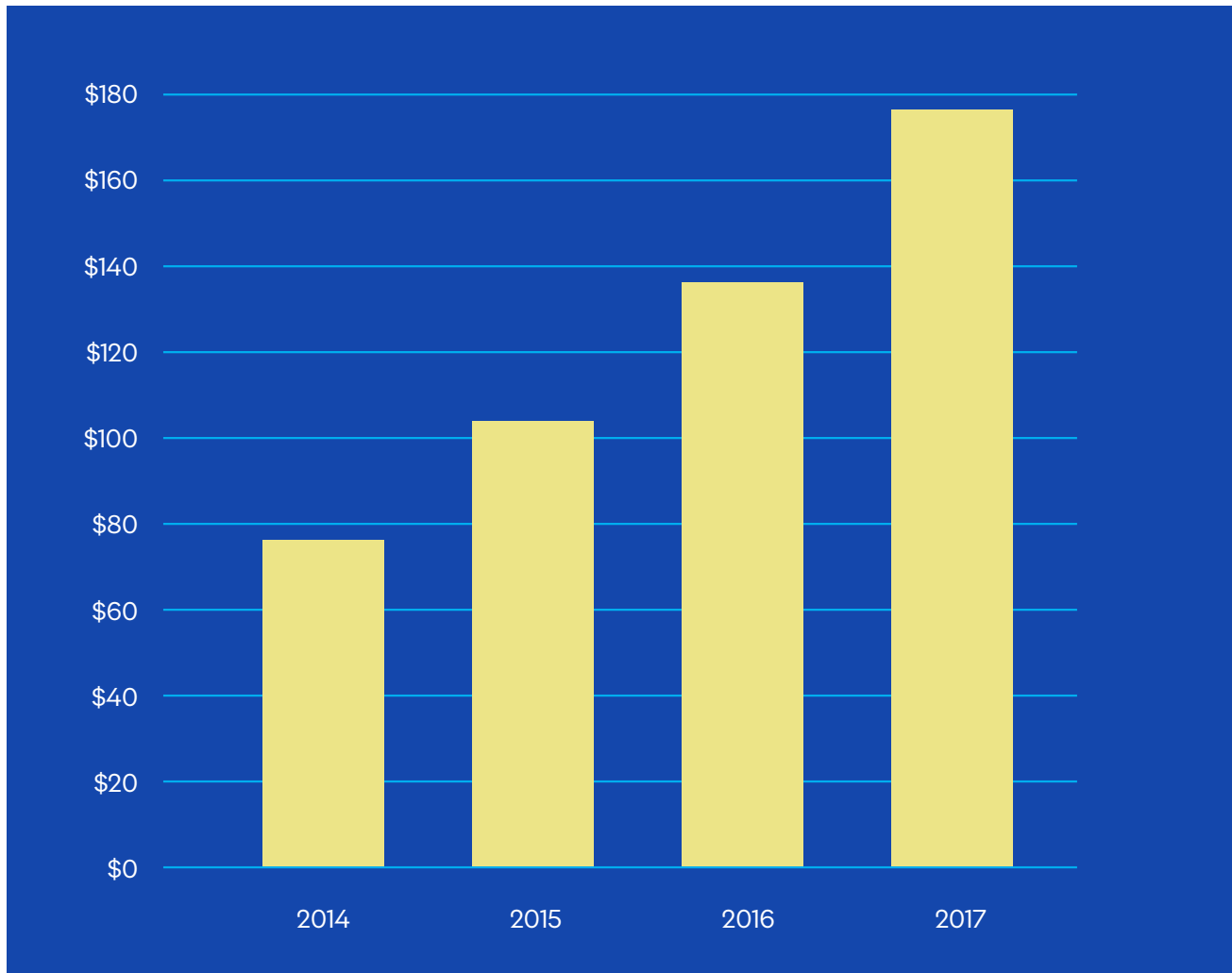

Figure 12

*Amazon shows 24% compound annual growth rate from 2013 - 2017. Source: CB Insights.*

### *What Does Amazon Want?*

We don't know. But something close to economic world domination isn't completely out of the question.

A generation ago, companies could surely be secretive about their plans. However, as technology's capabilities continue to exponentially, it's become far easier for the world's biggest corporations to hide their grandest of intentions in plain sight.

Before we delve into Amazon, a few daunting statistics:<sup>26</sup>

**300  
million**  
Active  
Users

Amazon has over 300MM active users with 100MM Prime members, or about half the adult U.S. population paying \$119/year for membership in the Amazon club--paying for efficiency as well as for Amazon to market more products via more of the data gathered over more devices.

**350  
million**  
Products  
for Sale

There are over 350 million products for sale on Amazon.

**1,300  
dollars**  
Annual  
Spend

Customer surveys reveal that Prime members spend \$1300 per year, and 95% are happy enough that they'll definitely or probably retain their membership.

**\$1  
trillion**  
Market  
Cap

Amazon's market cap is one trillion dollars.

I.09— "One thing is for certain," says Simpsons newscaster Ken Brockman as the world is taken over by ant overlords. "There's no stopping them."



Image 09  
Source: *The Simpsons*.

### *Clues to our Amazonian Future*

No one can know what Amazon wants, but we can speculate from listening to earnings calls and reviewing patents:

- Jeff Bezos has stated that he wants an “Alexa in every house in the world”
- Amazon will continue to automate retail until, like China’s JD, there are no humans in the warehouses—and once this technology exists, it will always exist.
- Amazon wants a much bigger business spread across a lot of new verticals—hence the acquisitions of PillPack and Whole Foods, and their patent forays into automotive repair.
- Amazon will pay for it all of its inventions via its unprecedented structure as a super company, wherein it can channel profits from any of its businesses into any other business—and then any advances made benefit all the other Amazon businesses.
- They are dead serious about drone delivery. It’s not one cutesy “attention-grabber” patent, it’s many.

## I.10—Things That Are Lost in a PowerPoint

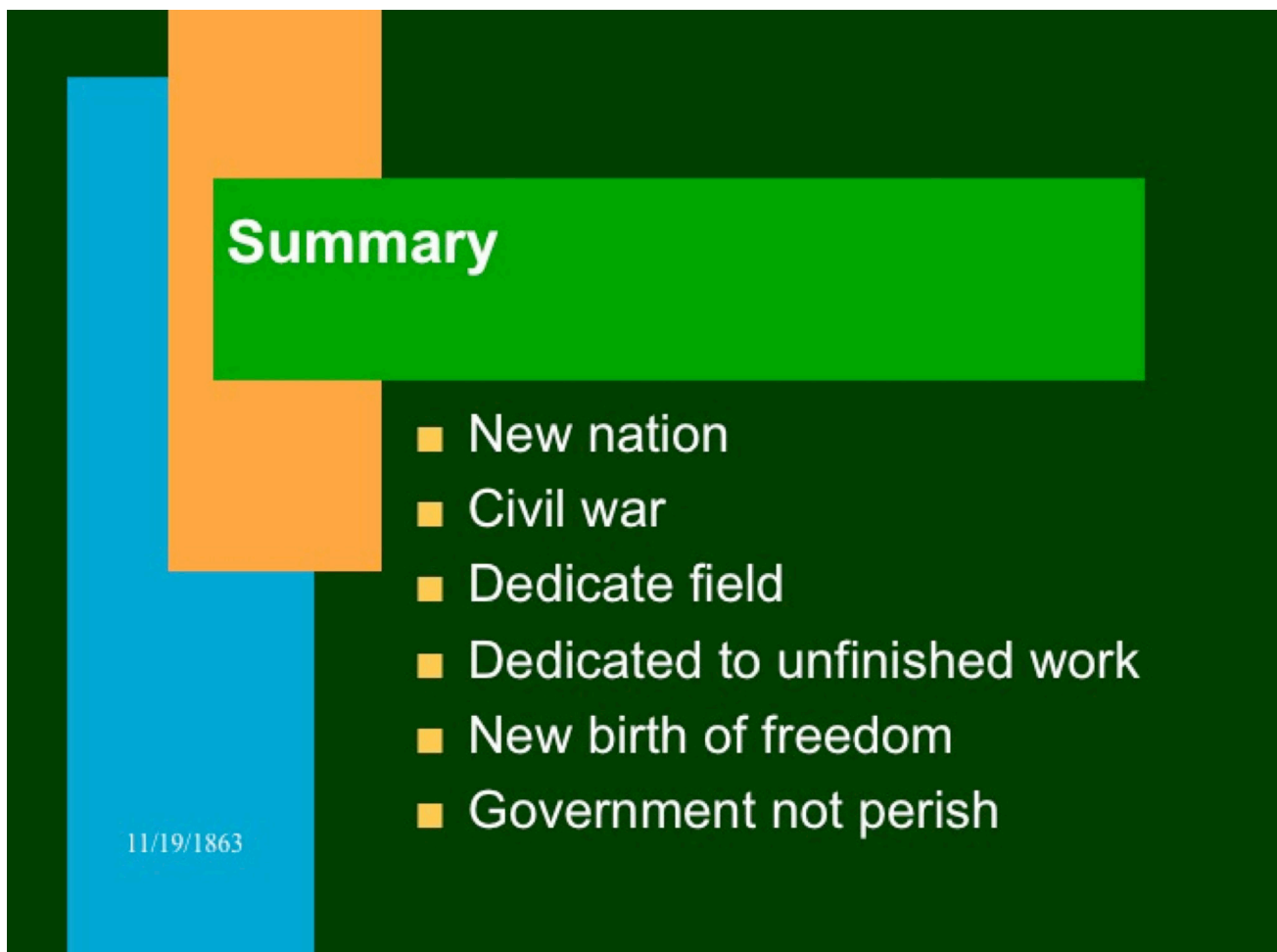

Image 10  
*Lincoln's Gettysburg Address as a PowerPoint. Source: Peter Norvig.*

Jeff Bezos plans five years in advance. He's recently said that when people congratulate him on having had a good quarter, that he quietly feels underwhelmed because "that good quarter was planned out years ago."<sup>27</sup>

He conducts this planning with what is probably the best strategy team available in the world, amid a culture that continually hones executives' analytical skills. **Jeff has outlawed PowerPoint** within Amazon, and requires his senior team to think in long form Word documents when laying out any new ideas for the company. He recently said, of these documents, "Some have the clarity of angels singing. They are brilliant and thoughtful and set up the meeting for high-quality discussion. Sometimes they come in at the other end of the spectrum."<sup>28</sup> It's a fascinating move: Word eschews brevity for accuracy.

So what are some of the gems inside those Word documents of late? We'll tease a few of Amazon's outlined plays, as the primary purpose of this report is not to demystify Amazon strategy (our friends at CB Insights do a great job of that) but instead to posit that the companies' effect on Millennials will be outsized.

## F.13—All the Ways Amazon is Unbundling the Bank

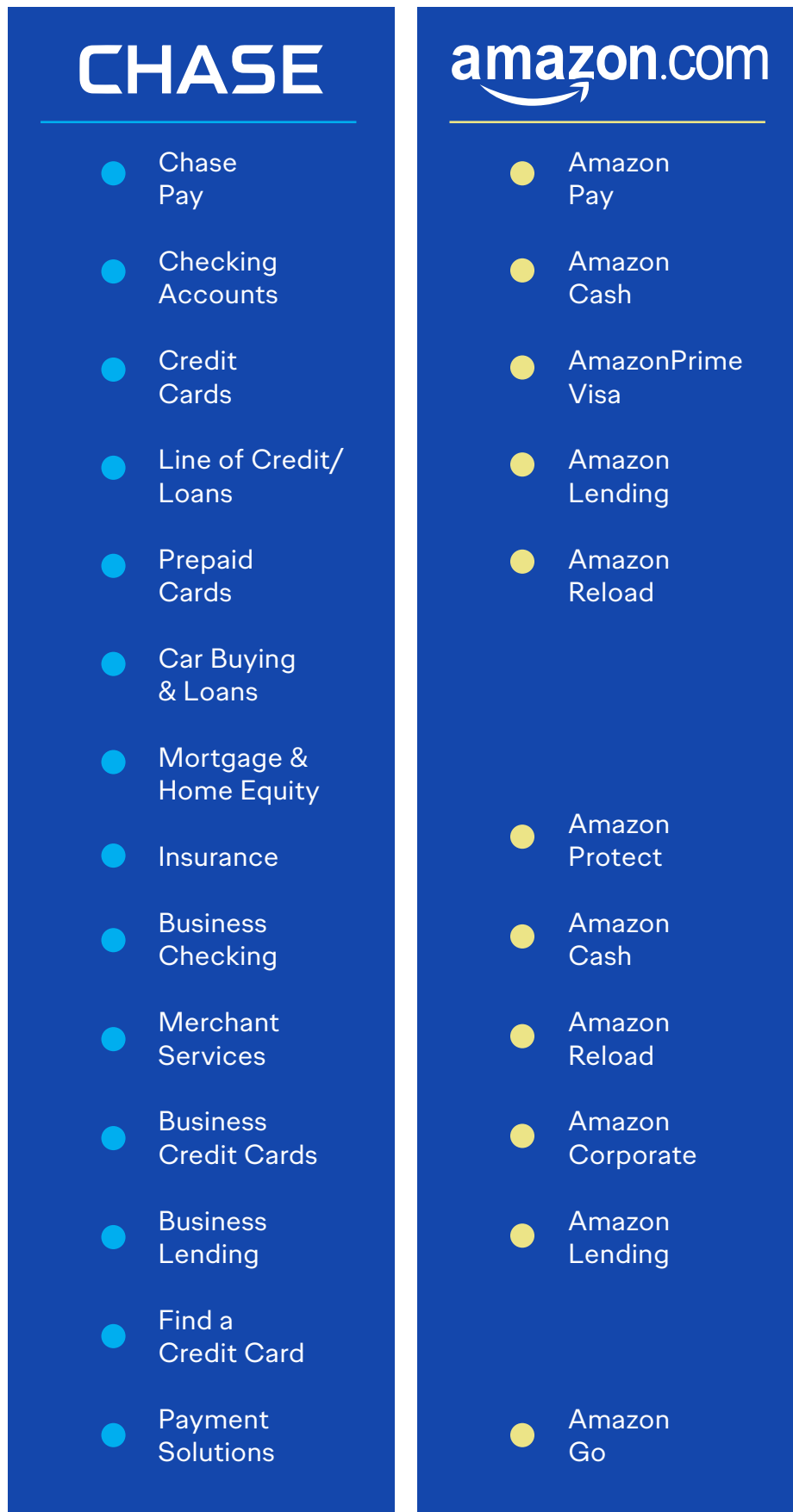

Figure 13  
Source: CB Insights.



## Amazon: 2020 & Beyond

### *Banking*

Banking is how Alibaba gained its power in China, and Mr. Bezos has surely taken notice. Alibaba's banks began by offering much better interest rates than the Chinese national banks, and sure enough, customers flocked to Alibaba's platforms. Alibaba also offered a wider range of services, like the ability to make withdrawals at any time without a penalty.

### *Auto Repair*

Again, per CB Insights, "Amazon is quietly building a substantial car repair service." Why is this play so intriguing? The average age of cars in the United States (and elsewhere) is breaking records: the usual car on the road is now an average of 11.5 years old.<sup>29</sup> Cars are lasting longer than they ever have before.

Leave it to Amazon to make the highest return, lowest required investment play... Why become one car company when you can service all of them? Car maintenance costs Americans more than groceries, says the U.S. Census.<sup>30</sup> Amazon's plan? For you to buy those spare parts online, and use augmented reality software to learn how to install them.

Reports *Mashable*: "Nicholas Farhi, an automotive services consultant at strategy firm OC&C, thinks car repair could be Amazon's next move. The company has already begun to offer various standard installations and fixes through its larger home and business service arm."<sup>31</sup>

## F.14—Profit Machine?

*After Years of Losses & Small Profits, Amazon Earnings Take Off*

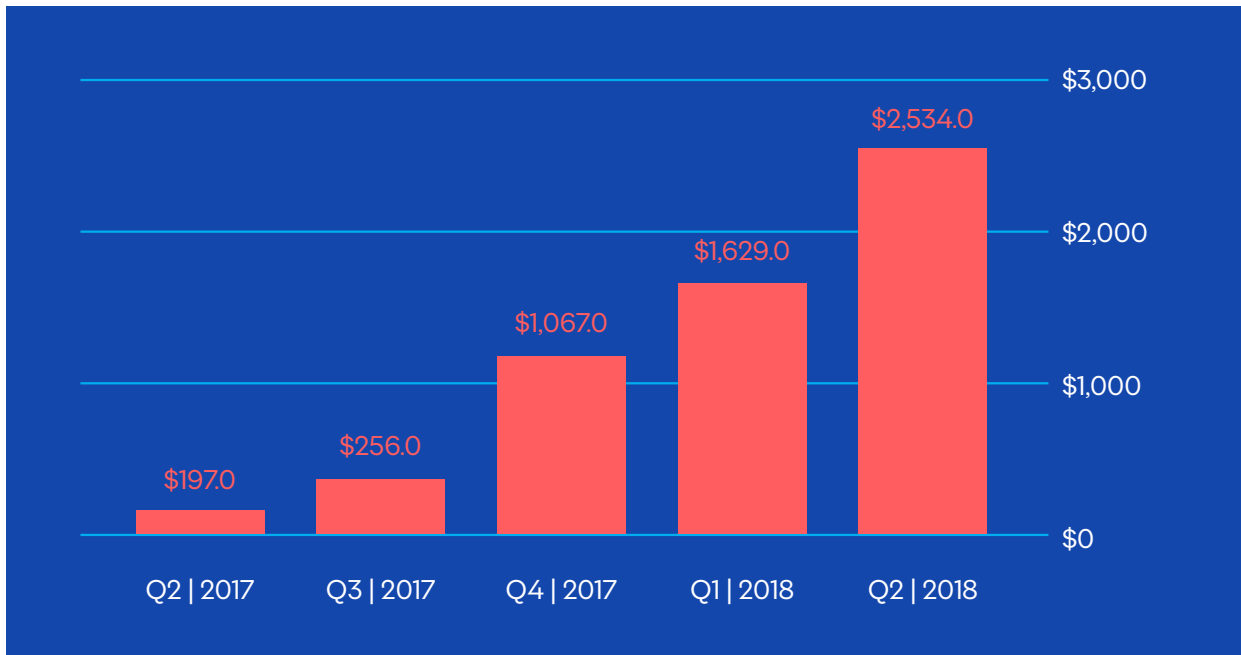

Amazon Quarterly Net Income (\$ Millions) ●

## F.15—Rising Cloud

*Amazon Unit Providing IT Infrastructure Services Sees Steady Growth*

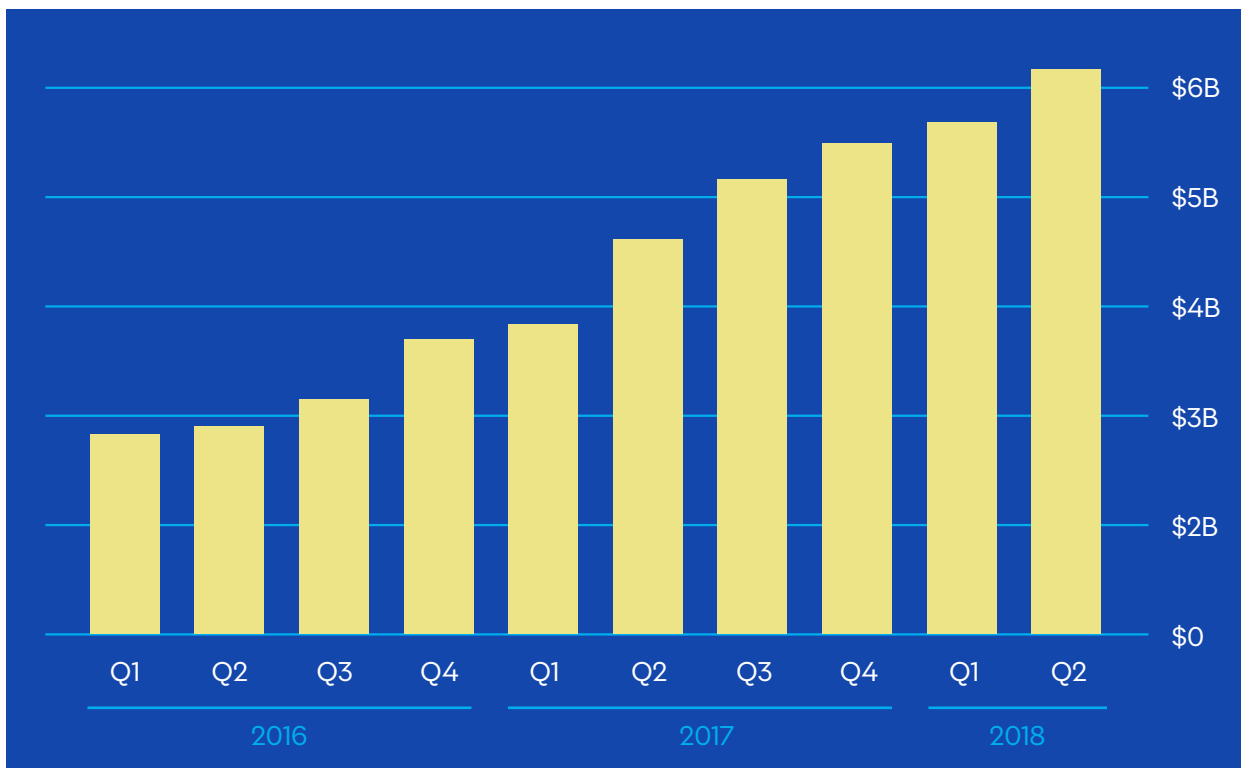

Amazon Web Services Quarterly Revenue ●

Figures 14-15  
Soper, Spencer.  
"Amazon's New  
Businesses Push  
Profit to a Record,"  
Bloomberg, July  
26, 2018.

## Centralized Government Cloud Contracts

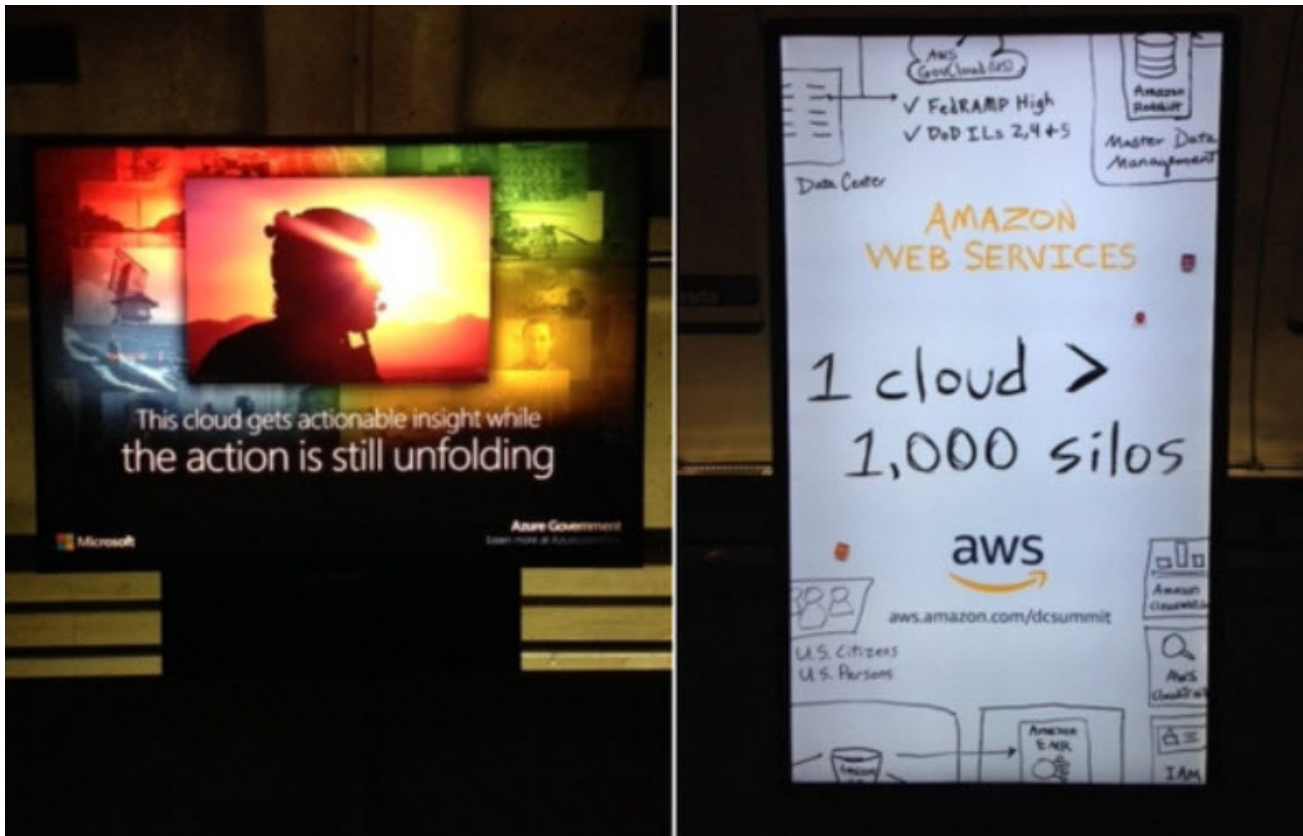

Pop Quiz: What are these subway posters for?

Oh no big deal, it's just Amazon and Microsoft competing to provide data storage for highly classified information. (Amazon is largely considered to have a significant advantage here.)<sup>32</sup> **As of late 2018, Amazon is currently in a bidding war against other technology companies to offer cloud computing to the U.S. Defense Department.**

AWS, or Amazon Web Services, is the under-discussed powerhouse behind Amazon's success. With many of the biggest companies in the world as clients, Amazon's extremely cost-efficient, sticky services are a key component of many other companies' revenues.

## F.16—Number of Patents *Filed* by Walmart & Amazon

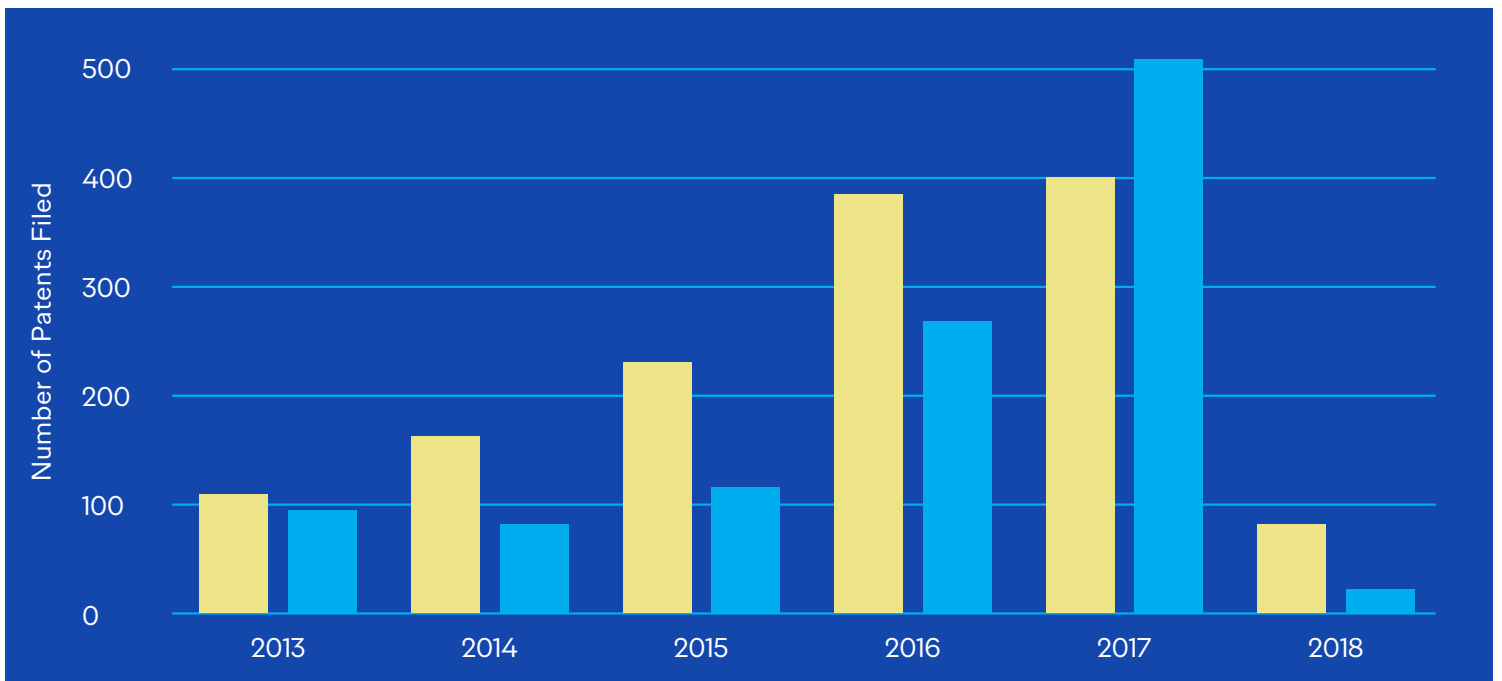

Figure 16  
Source: CB Insights

● Amazon  
● Walmart

## F.17—Number of Patents *Granted* to Walmart & Amazon

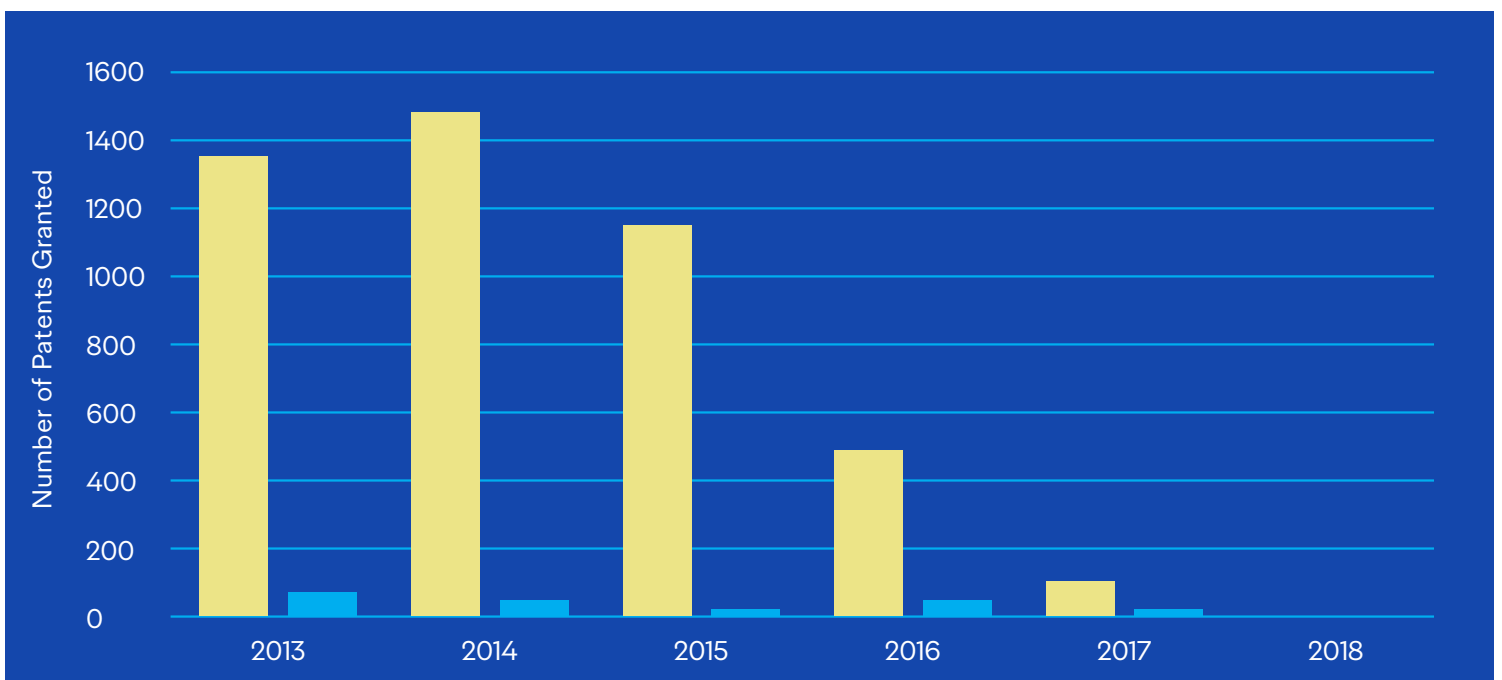

Figure 17  
Source: CB Insights

● Amazon  
● Walmart

### *Healthcare*

As CB Insights reports: "Amazon is going after healthcare. Its investment into cancer detection company GRAIL was a vote of confidence in genomics, which with its massive data and processing needs, will be a major area for computing. In addition, Amazon's recent partnership with JP Morgan and Berkshire Hathaway to provide employees with better health insurance signals broader ambitions to upend traditional healthcare."

### *Walmart: The Amazon Competitor*

Amazon's closest competitor is arguably still Walmart, and Walmart's formidable: they're the largest company by revenue in the world, they're extremely good at logistics, and they have zero regard for humanity, given that their family fortune is the biggest on earth, and their workers use food stamps to shop within their own stores. Walmart is totally unafraid to fight dirty, so they're formidable.

Using CB Insights tools, let's see how they're faring so far. The first indicator: patent filings. Both companies are filing for a lot of patents (though of course, Amazon's filing for more).

However, when we look at patent grants, it's a totally different ball game. Amazon is crushing Walmart.

## F.18—Labor’s Share of Profits *1947 - 2016*



Figure 18

Source: U.S. Bureau of Labor Statistics.

When we delve into the content of the patents, we see an even more disproportional fight, in that Amazon's patents are far more grandiose in scope than Walmart's. For example, in 2017, three of Walmart's patents are for better bagging terminals. Now, this is nothing to shirk at, Walmart built a lot of its wealth on genius incremental improvements (and, of course, paying employees so unfairly, they were the subject of the largest ever class action lawsuit, *Dukes vs. Walmart*).

Amazon's patents, by comparison, are positively space age. A recently granted patent is for "obtaining virtual machine images from virtualization environments."

Amazon and its crazy-big plans prove that.

### *Automation isn't Coming, Automation is Already Here*

Back in 2013, Oxford University economists estimated that a staggering 47% of jobs would be taken over by computers.<sup>33</sup> By 2018, as driverless cars taunt truck drivers and Walmart finally begins to fall prey to Amazon, those economists were already being proven right.

Automation is why wealth is so poorly distributed among Millennials. As the *New York Times* recently reported, "What's different about new superstar firms is they don't have the cadre of middle-class jobs for nonelite workers," said Lawrence Katz, an economics professor at Harvard."<sup>34</sup>



### *Automation's Biggest Problem? It's Still Culturally Invisible*

When we talk about “jobs” in America, we’re often really talking about automation. We use the word “jobs” because it’s easier.

The pleasant vagueness surrounding the word "jobs" is how Donald Trump, a semi-literate binge eater who’s afraid of stairs, became president. While American companies produced record profits by automating their call centers, cashiers and factory floors, Trump flew his golden plane around the country and told his audiences something they already knew by experience: the jobs had gone missing. He’d stumbled upon the the magic idea. As the law professor Joan C. Williams wrote in her excellent 2016 book *White Working Class*, “What Trump voters want are stable, full-time jobs that deliver a solid middle-class life to the 75% of Americans who don’t have a college degree.”<sup>35</sup>

As Hillary Clinton reflected in her latest memoir, *What Happened*, she never once mentioned her deep concerns about workforce automation when still on the campaign trail. “My staff lived in fear that I’d start talking about ‘the rise of robots’ in some Iowa town hall,” she wrote, “...Maybe I should have.”<sup>36</sup>

Robots aren’t depicted in *Shondaland*, nor seduced in the lyrics of Justin Bieber, nor portrayed in the novels penned by the elite team of writers who call themselves James Patterson. As a culture, we allow automation to hide in plain sight.

Given the lack of narrative, it's no wonder America is handling this transition very badly: in March, 2017, a paper by two Princeton economists revealed that Americans are disproportionately dying from what's called "deaths of despair" (addiction, alcohol, suicide, and related illnesses). The study concluded that "the trend is driven by the loss of steady middle-income jobs for those with a high school diploma or less."

Millennials know there's something off-kilter with their economy, you can see rampant evidence of this in their memes and political stances. "Old Economy Steve" is one of the closest things Millennials have to an automation-era work narrative. He's a Baby Boomer who believes Millennials are lazy and entitled, without understanding any of the sweeping macroeconomic variables that assisted in his rise. (A lack of student debt, higher wages, etc.)

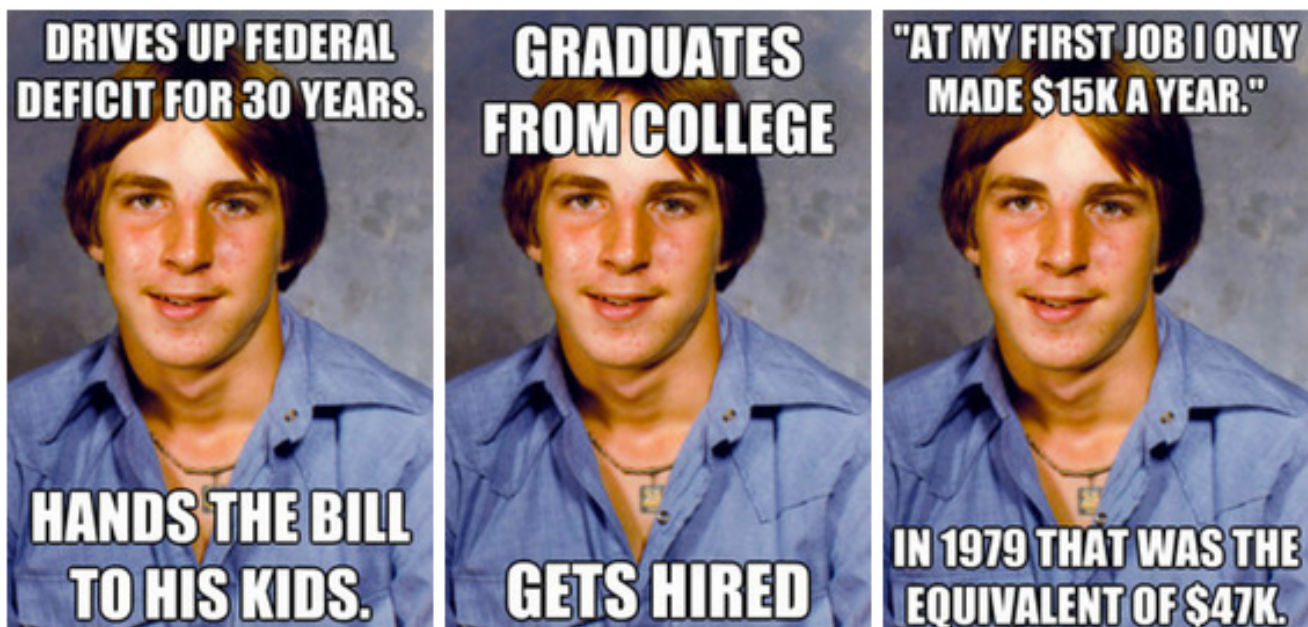

Image 11

"Old Economy Steve." Source: BuzzFeed.

### *Millennials Support a Regulated Amazon*

At only 29, Yale law student Lina Khan has already gone viral with a paper outlining how and why Amazon is violating anti-trust law, albeit in a very clever fashion.<sup>37</sup>

As *The Atlantic* recently wrote of Ms. Khan, she argues that Amazon uses its influence directly and indirectly to alter our economic landscape. She explained:



Image 12  
Look out,  
Amazon,  
Millennial Lina  
Khan is fighting  
back. Source:  
C-Span.

“*When a company has such power, it will almost inevitably wield that power far and wide, distorting not just the market itself, but the whole of American life. With sufficient power, companies can commission studies, rewrite regulations, bulldoze neighborhoods, and impoverish education and welfare systems by securing billions in sweetheart tax cuts. When a company comes to monopolize a market—when it grows so big that it can threaten other industries just by entering them—it ceases to be merely a company. It becomes an institution so powerful that it can rule over people like a government.*”

### *All This Said, There Are Many Good Sides To Automation*

The most impressive, foolproof business models are resilient and futuristic enough to thrive in a post-employment world, and do so in a way that lifts quality of life expectations for everyone, not just the few. This is why we're still bullish on AirBnB.

Plenty, the farming startup, is an ingenious Millennial example of automation being used to improve the lives of the many. As one of Jeff Bezos' biggest investment bets, Plenty is this hydroponic, vertical indoor farming company that can produce between 150-350x the output of a comparable field farm in only one location.

Plenty is headquartered in San Francisco, but has offices in China and Japan.

As technologies like Plenty normalize new growing techniques like biomes and vertical gardens, harvesting basic greenery will likely be a process that we likely integrate into our daily lives (even if we're city dwellers, which 54% of us already are, with that number climbing to 66% by 2050.)

The best part about this highly global trend? It's equality-minded. In fact, the wildly ambitious, global indoor farming startup Plenty is focused especially on urban food deserts, where most residents lack access to fresh produce.





Image 13

*The farming startup Plenty is reshaping how we grow food. Image source: Plenty Ag.*



## The Millennial Economy

### *In Conclusion*

At only 1% of worldwide retail, Amazon has plenty of growing left to do.<sup>38</sup> Millennials must decide if they want Jeff Bezos to write vast swaths of their economic future alone, or if they'd prefer to have a regulatory hand in the matter.

Fissured work will come under fire—Millennials' love of unions will absolutely assure that one. What new ways can we structure work relationships that avoid the unfairness of the fissured model?

Asking Millennials to choose between “shit jobs” and “bullshit jobs” is no way to build the future of the economy. Keynes knew it, Marx knew it, even Adam Smith knew it. How can meaning be imbued into Millennials' daily work lives? As a first step, should every company pull a Salesforce, and use 1% of all employee time for charity? What's more ambitious than that, what could come next? These are the questions that will preoccupy Millennials' minds as they begin to ascend within corporations.





02 PART II of III

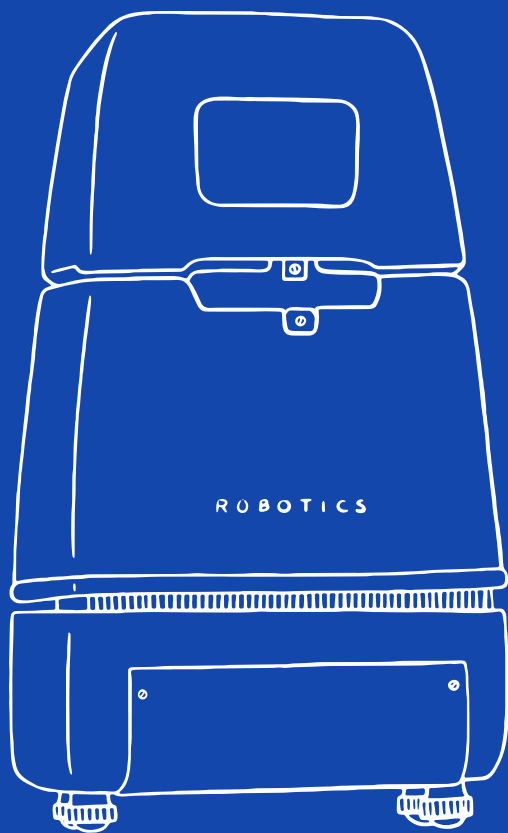

# Millennial Culture

*Evolution & Contradiction*

## Millennial Culture *Evolution & Contradiction*

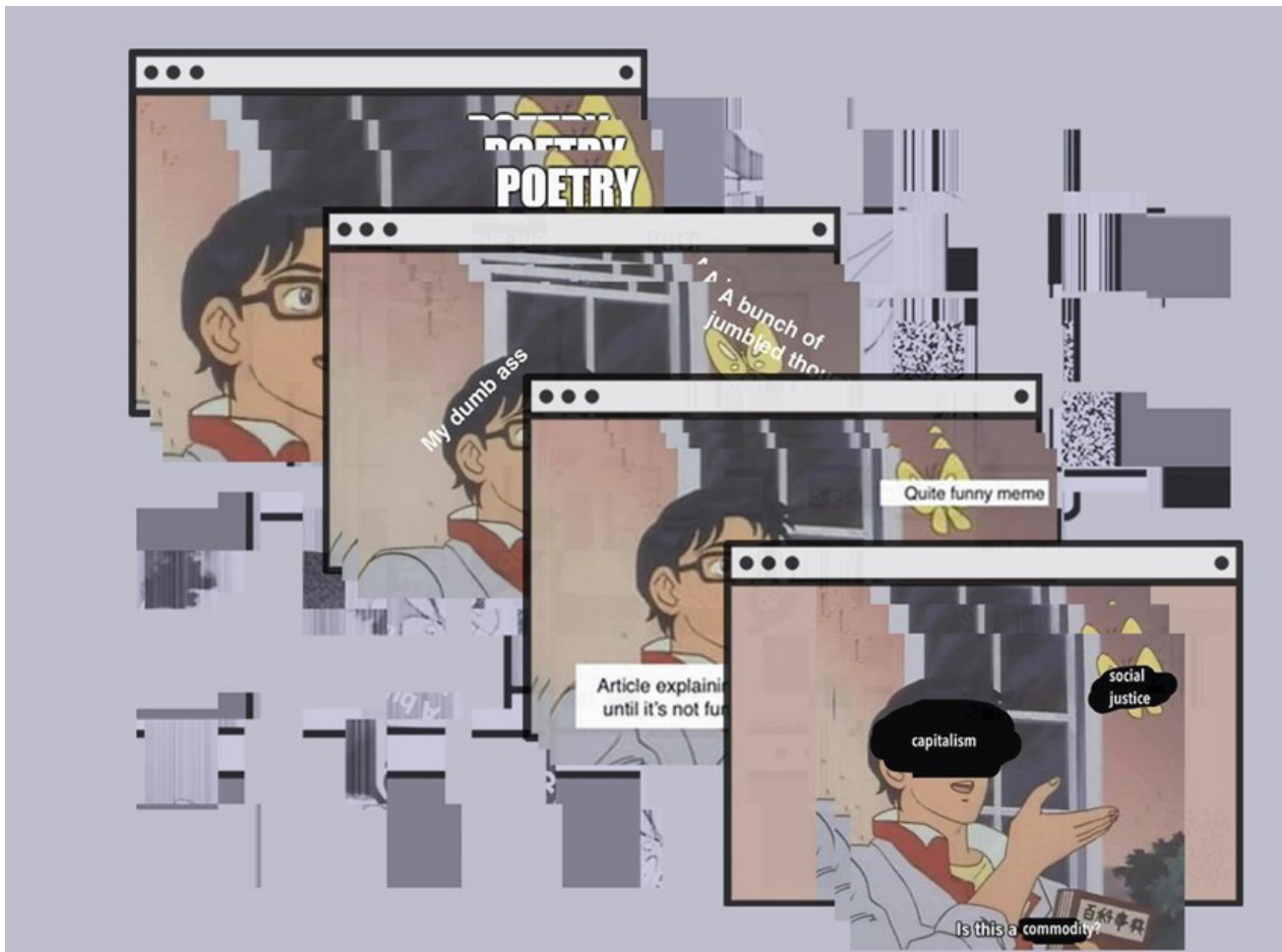

*Everybody thinks in memes now. We don't have to actually know about things to know them anymore. "Memethink" is a term that describes the way people today understand the context of specific cultural items implicitly. Take, for example, avocado toast. While conducting research around the American South last summer, cultural researchers Sean Monahan and Sophie Secaf kept hearing: 'You know, these kids in New York, they're all about their avocado toast.'*

DAZED MAGAZINE, JULY 2018

Across the socioeconomic spectrum—and despite veering toward middle age—Millennials still seem very, er, youthful. Whether it’s Botox, lip filler, the dominance of “athleisure” fashion, the narcissism of social media, the endless screen time, or the horrid verbing of “adulting,” it seems challenging for many people in their 20s or 30s to act their age.

Let’s delve into why for a minute.

In her excellent 2017 book *iGen*, psychologist Jean Twenge posits that time has simply become more elastic for this cohort. They had longer childhoods with shorter leashes (10 year olds given the responsibilities of 8 year olds, 16 year olds treated more like 12 year olds, etc.) She cites “life history theory,” or the idea that “today’s [young people] follow a slow life strategy, common in times and places where families have fewer children and cultivate each child longer and more intensely. [...] In the United States, the average family has two children.”

Aside from the rise of social media (which we’ll discuss in a moment) in Millennials’ teenage years, they were less likely to believe in a religion, hold an after school job, get their drivers’ license, be a latchkey kid, try alcohol, or have sex than the two prior generations. So you net out with a kid that, in some ways, is responsible (the no booze and sex thing), but also is a gigantic baby.

### F.19—As Technology Abounds, Millennials are Increasingly Miserable

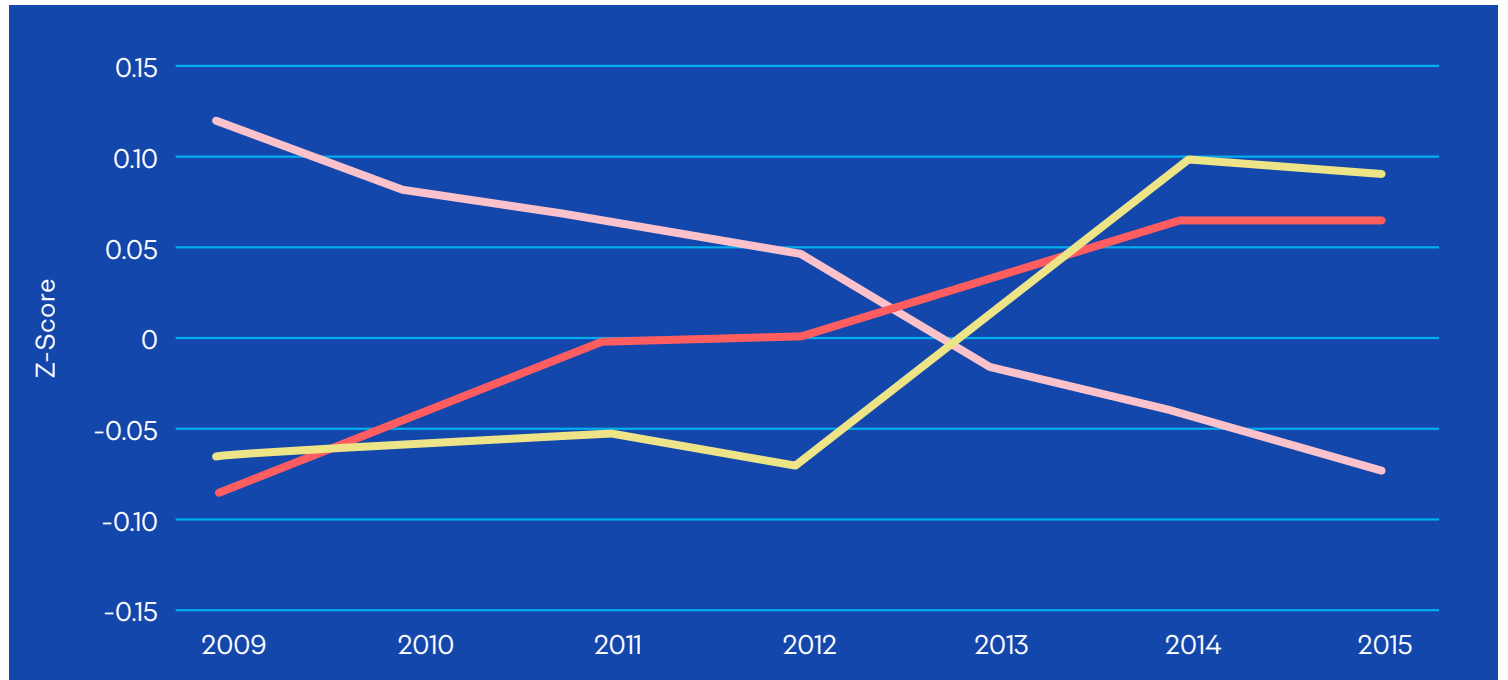

Figure 19  
Twenge, Jean, *iGen*, Atria Books, 2017.

● Depressive Symptoms    ● Screen Activities    ● Nonscreen Activities

### F.20—Change in College Students’ Narcissistic Personality Inventory

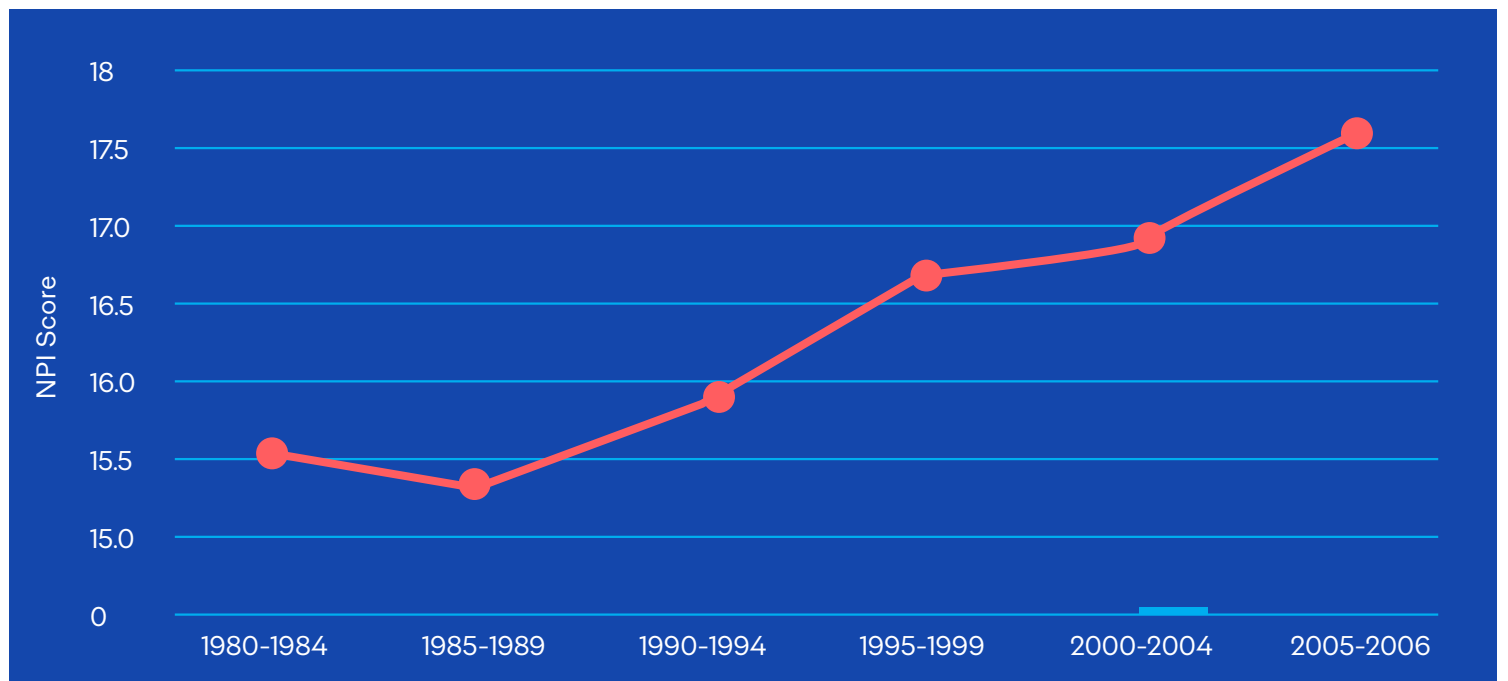

Figure 20  
Twenge, Jean, *iGen*, Atria Books, 2017.

### *Distraction Worship*

Millennials now spend a lot of time on social media, and research is continually proving that social media is great at making people narcissistic and miserable. However, phone platitudes aside, Millennial culture has also brought the rise of phenomena like adult coloring books, and, as Twenge notes in her book, brands that are eager to “tap into anxieties about growing up.” One is reminded of Herbert Marcuse’s theory of sublimation from *The One Dimensional Man*, wherein he theorized (back in 1964) that although “The pre-technical world was permeated with misery, toil, and filth, these in turn were the background of all pleasure and joy.” Marcuse believed that modernity and all its triviality (and lack of back-breaking work) would “precondition [us] for the spontaneous acceptance of what is offered.”

In short, after Keynes predicted that technology’s proliferation would liberate us because it would mean we’d have a grand amount of free time, Marcuse doubted our ability to thrive in such an environment. He thought it would make us dumb and unquestioning. “Under the conditions of a rising standard of living, non-conformity with the system itself appears to be socially useless.” Keynes seemed to picture us relaxing under trees, playing harps and reciting Aristotle. Marcuse pictured us... Getting sucked into something like social media.

Marcuse was not alone in his cynicism. Postman and Debord all theorized that screens would render us rather pliant, passive and easily manipulated. These postmodern philosophers also call to light a phenomena that Millennials will have to solve for: even though technology can gift us longer, healthier lives, it lacks something distinctly human that we all require: a sense of belonging and purpose.



I.14—Lauren Greenfield captures wealth worship.



Image 14  
*Greenfield, Lauren, Generation Wealth.*

## *Wealth Worship*

*A conversation about generational wealth in America is, of course, a conversation about whiteness.*

JIA TOLENTINO, THE NEW YORKER

White American college graduates are about three times as wealthy as black American college graduates.<sup>39</sup> Implicit in the inequality that still paralyzes the Millennial generation is the systematic racism atop which America was built.

Millennials have come of age amid extreme wealth envy and wealth worship, a reality meticulously documented by photographer Lauren Greenfield. (You likely know Lauren from her documentary *The Queen of Versailles*.)

With a golden gut, Ms. Greenfield began snapping pictures of Americans interacting with wealth when Kim Kardashian was 12 years old. 25 years later, she's released the multi-media project *Generation Wealth*, which perfectly tracks Millennial's childhoods, and, regardless of actual familial income level, their admiration of wealth. 500,000 photos' worth. Defining "wealth" broadly, Ms. Greenfield documents how we "export the values of materialism, celebrity culture, and social status to every corner of the globe."

Pundits will often bemoan certain groups of Americans for being uninterested in voting in their own interest. (Why would anyone who needs food stamps vote against policies that improve and expand food stamps, etc.) There is a second, very different map of those making purchases they cannot actually afford, and that map is a lot of Millennial America. (Proof? Millennials' low savings rates.)



# I.15—There are signs that Millennials are tiring of wealth worship.



Image 15  
Wagner, Kate, McMansion Hell.

### *A Fascinating, Hopeful Millennial Counter-Trend: #VanLife*

There are signs that Millennials are also tiring of the ceaselessness of mindless wealth worship. The popular *Tumblr McMansion Hell*, run by 24 year old Kate Wagner, uses McMansions to teach readers about architecture, and also explain why so much of Gen X's idealized "McMansion" home is completely ridiculous.

Other Millennials explore options beyond having apartments and homes at all.

As the *New Yorker* wrote when covering the #vanlife trend last year,

*For all its twee escapism, vanlife is a trend born out of the recent recession. "We heard all these promises about what will happen after you go to college and get a degree," Smith said. "We graduated at a time when all that turned out to be a bunch of bullshit." The generation that's fuelling the trend has significantly more student debt and lower rates of homeownership than previous cohorts. The rise of contract and temporary labor has further eroded young people's financial stability. "I think there's a sense of hopelessness in my generation, in terms of jobs," Foster Huntington said. "And it's cheap to live in a van."*

These are meaningful responses worthy of consideration...especially if we're eventually heading toward a model like Universal Basic Income, where people don't need to work to survive.



## I.16—Some Millennials are living out of their vans.



Image 16  
*Images of the popular trend #vanlife. Sources: Adventure in You, YMOZ.*

“I’m not doing anything all that interesting; I’m just trying to live my life out of a van,” writer and blogger Brent Rose told me over email. “Yet tens of thousands of people want to read about what I experience on a daily basis. I figure it must mean something. What, I don’t know. Maybe people feel the same dread that I felt about making rent every month. Or maybe they’re laughing at me. Who knows! But it means something.”

On a smaller scale, the starter Tentrr has seen real success. The company is an Airbnb of “glamping,” aka glamorous camping, or camping without carry-in, carry-out-style expectations. (There’s a ready-made canvas tent on a wooden platform involved, eliminating the need for a Tentrr user to own or even set up a tent—or worry too much about rainfall and tent placement.)

These little signs are important: perhaps there is actually a limit to how much media a mind can consume before it craves something else, something like the comfort of nature.



## I.17—Millennials gravitate toward political music.



Image 17  
*Beyoncé (above) and Kendrick Lamar (below). Sources: Mercury News, Grammy.*

*Another Hopeful Counter-Trend:*

*Beyonce, Kendrick Lamar, Childish Gambino, and many more*

In our last trend report, we cited Kendrick Lamar’s phenomenally political music as a reason for hope in Millennial culture. Since then, hip-hop finally became the dominant genre in American music—so bye bye bye, N\*Sync et al, and we won’t miss your insipidness.

As music stars use their platforms to speak out—and seriously—about the issues facing Millennials. One in five Americans have protested in the streets or participated in a political rally since the start of 2016.<sup>40</sup> Now is the time for action. It’s not the death of jokes—we need those, too—but it’s an acknowledgement that no one’s changed the world with one-liners. Not Martin Luther, nor Martin Luther King Jr. Political rhetoric requires weight.

*One Last Note: Does Generation Z Understand The World—  
Online & Off—Better Than Millennials?*

While the Millennials meme their sadness real and imagined, their little brothers and sisters are using social media perhaps as it was always intended.

In the fall of 2018, the Obama and Oprah-endorsed high school students behind March For Our Lives are taking their show on the road, galvanizing young people to vote (only 50% of Millennials voted in the 2016 election, and not many more voted in the 2008 and 2012 elections) and to vote in favor of gun safety.



I.18—March For Our Lives is a multi-million dollar operation.



Image 18

*David Hogg addresses the March For Our Lives rally in Washington D.C., March 2018. Source: National Review.*



## I.19—Teens are protesting to save the planet from climate change.

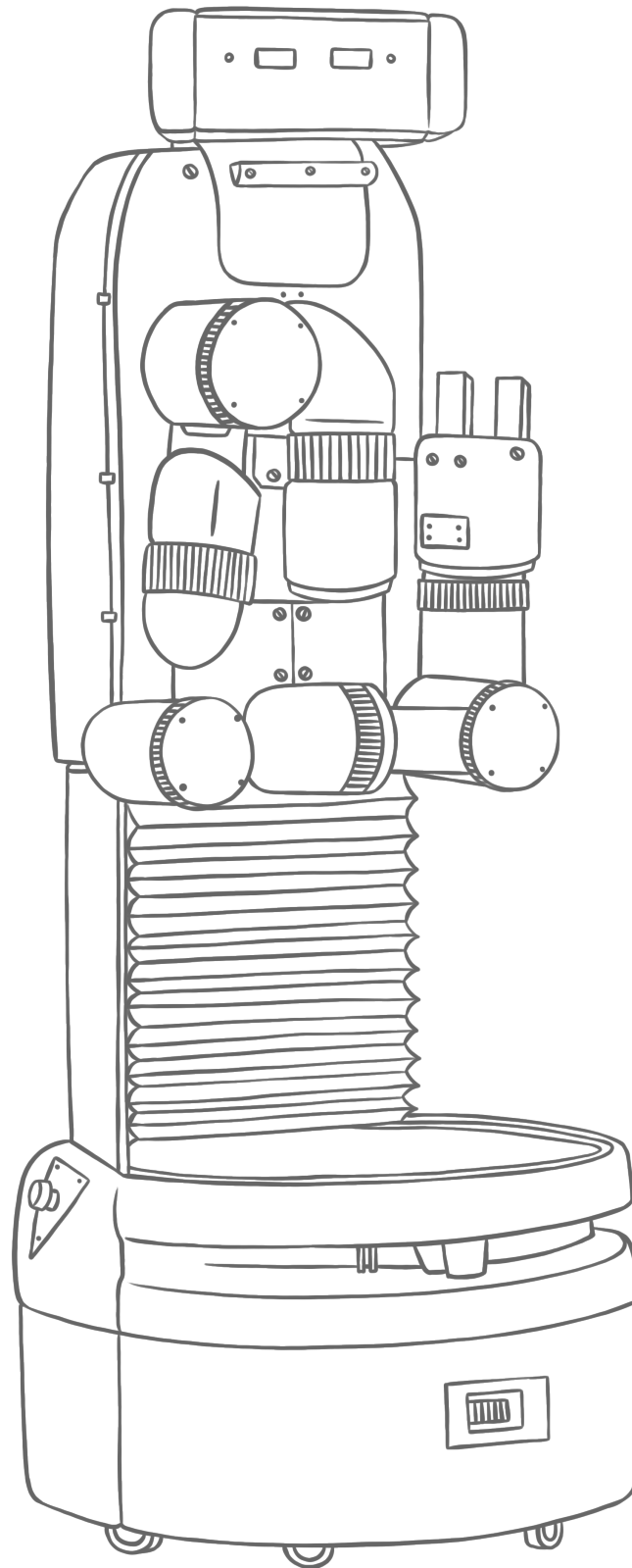

Image 19 Young demonstrators are leading the charge on climate change. Source: Gizmodo.

As reported by the *Miami Herald* via *Axios*, March for Our Lives, the gun control movement launched this year by survivors of the Parkland high school shooting, has incorporated as a 501(c)(4) nonprofit organization with “a multi-million dollar budget, offices in South Florida and Washington, and even its own lobbyist.”<sup>41</sup>

As the March For Our Lives students seek bipartisan gun reform, their newest partners in creating a better world are over at Zero Hour, the high school student-founded initiative to force politicians to face facts on climate change.

It’s inspiring to think about the kinds of jobs that these young people will deify in their coming years. Perhaps it won’t be the TV celebrities of the world, but instead the activist/politician/scientist celebrities. The future MLKs, FDRs, Hedy Lamarrs.



## Millennial Culture

### *In Conclusion*

There is a world wherein Millennials can retain serious information about a topic, digest it, debate it, and then act on it—and also enjoy the occasional meme-feast.

Perhaps it's the tools that need to change: as McLuhan, Debord, Eisenstein, Postman and countless other media theorists have reminded us through the ages, we make our media tools, and then our media tools make us.

Childhood gets old. There will be first-mover advantages for the Millennial entities that eschew it for something more meaningful. There will be a Walter Cronkite Millennial. Case in point: back when *The Sopranos* came along, most television was insipid. That's what we knew television to be. Then David Chase and HBO decided to completely reset the standards. The same change is long overdue to happen within Millennial culture and Millennial media. It will be met with open arms. Why underestimate when you can overestimate?



03 PART III of III

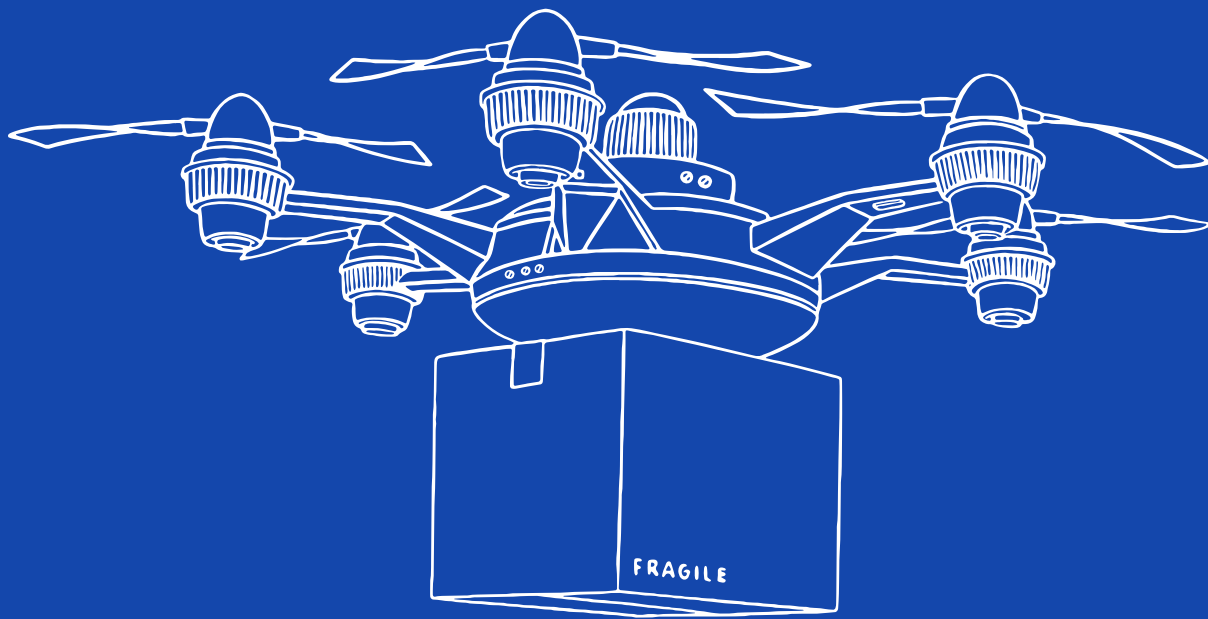

# Millennials, Advertising, & Media

*Drone or Billboard or Both?*

# I.20 – Amazon drone technology systems.

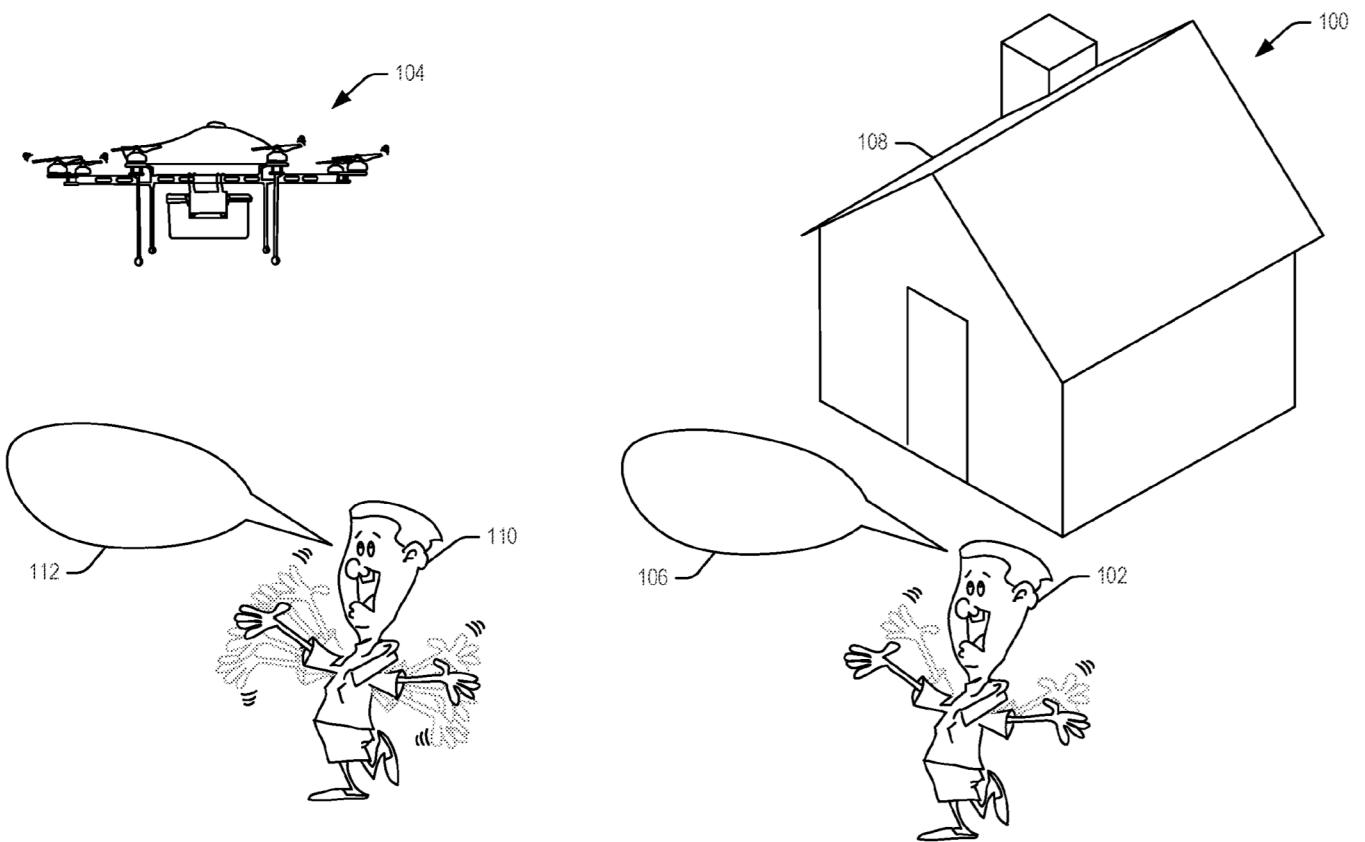
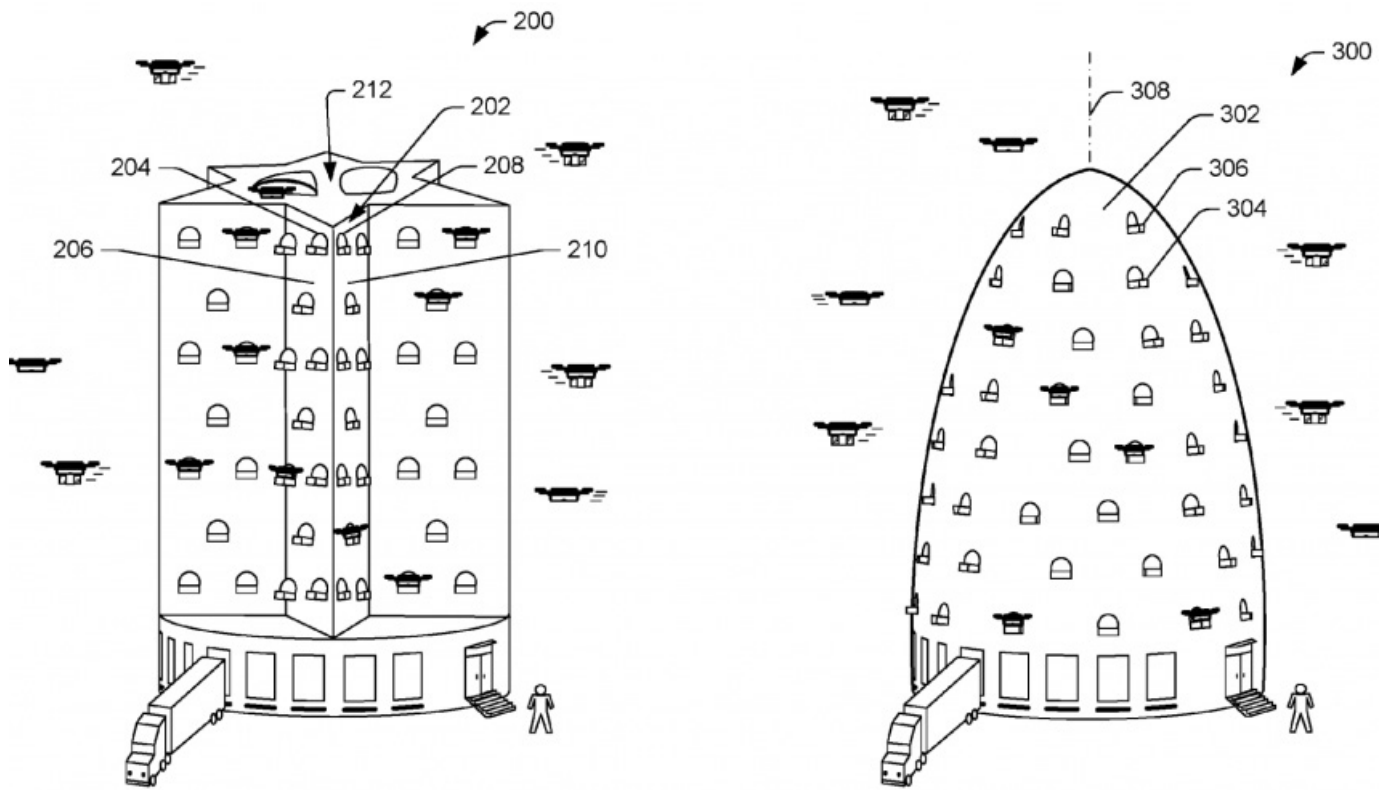

Image 20  
Amazon patents. Sources: CNN Money, Newsweek.

## Millennials, Advertising, & Media

### *Drone or Billboard or Both?*

The advertisement of the future looks nothing like the advertisement of the past.

Case in point: these little doohickeys—Amazon drones entering and exiting an Amazon “beehive,” as illustrated in a recently granted Amazon patent—might well be as common a place for advertisements in 10 years as a billboard is today. Only this billboard will be be a ultra personalized to your exact needs, in your exact time and place.

Imagine this scenario: you’re at a baseball game, and you use your phone to order snacks from the Amazon drone hovering overhead. Meanwhile, your son mentions he desperately needs school supplies for a last minute project due the next day. Amazon, which has already authorized itself in your TOS to listen in on your conversations (one of the patents for this particular technology is called a “voice sniffer algorithm,” which can “get to know you” and make “personalized offers on products, encourage [you] to take action, or better persuade [you] to buy a product,”) <sup>42</sup> offers to help out. It analyzes your conversation with your son and prepares an order of all the goods he likely needs for his history project, and then asks you to approve the rush order, which it will send to your house in an hour, when traffic says you’ll be home.

Is this an advertisement? Yes. Amazon is advertising the goods you should buy for your son’s history project, and then you’re buying them. It’s just a far more sophisticated advertising tool than we’ve ever seen before.

Hence the future of advertising *looking* nothing like anything from the past.



## F.21—Sizing Up the Competition

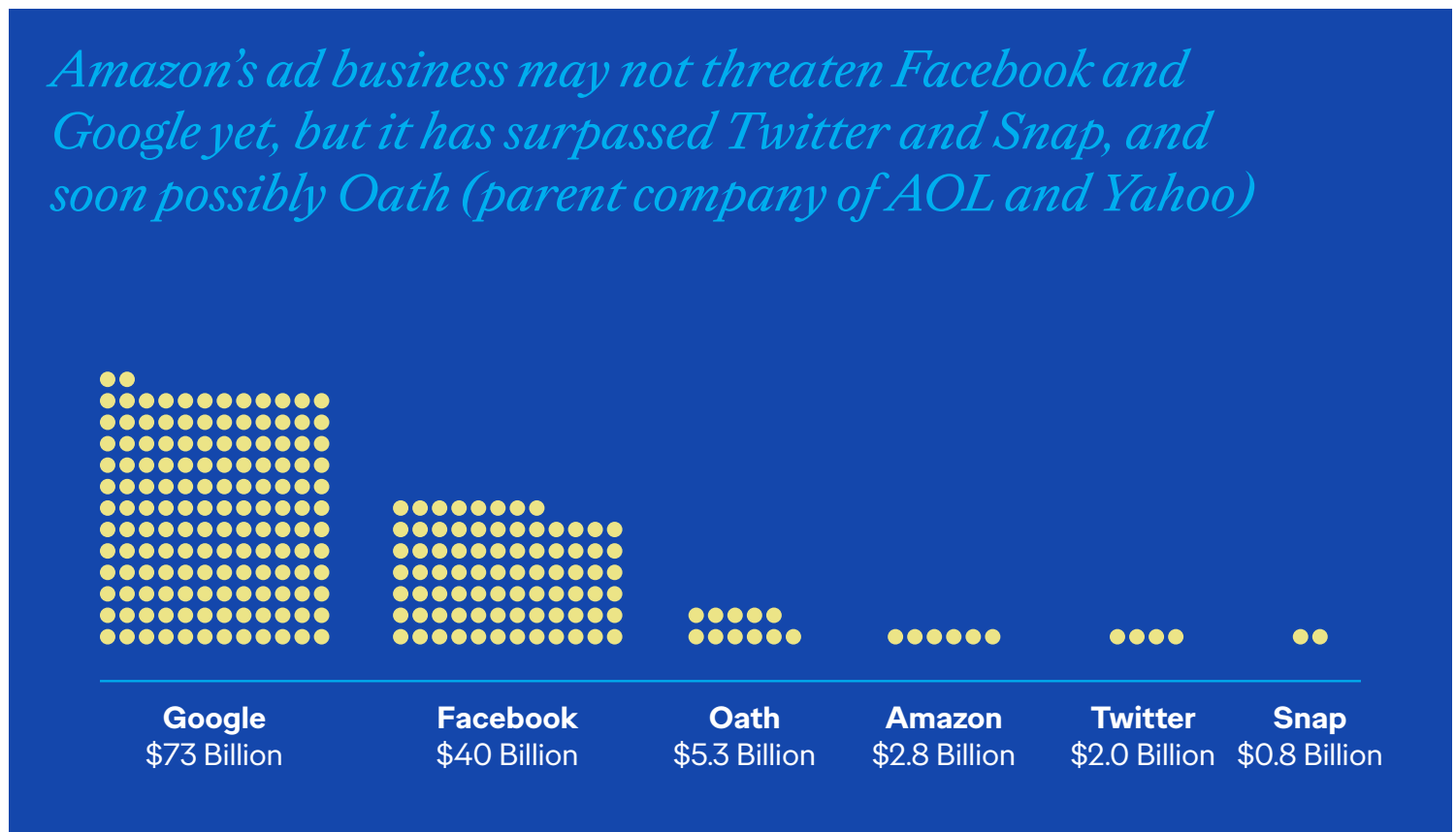

Figure 21  
Source: Wall Street Journal

● 1 block = \$500MM in estimated worldwide 2017 ad revenue

### *Amazon as Advertising Conglomerate*

Much like WPP, Facebook and Google before it, Amazon is quietly shifting its business model (from plastics, social connections and search, respectively) to advertising. Many of the company's granted patents allow for massive expansion in distribution and intelligence-gathering technologies. Combine the two, and you remove much of the guesswork involved in advertising. Instead of the advertisement prompting consideration, it just directly prompts purchase.

Amazon's already gained serious growth from third-party sellers. (40% of all their sales come from third-party sellers.)<sup>43</sup> In a way, Amazon acts as the billboard for all these companies (and therefore does their advertising).

From *Gizmodo*:<sup>44</sup>

*“Amazon's patent suggests a future where its delivery drones, after launching from a delivery truck, would navigate to your home using visual cues, voice commands, and gestures from humans to establish and maintain its flight path. Humans could wave the drone away, tell it to deliver something next door, or perhaps instruct it to leave before you shoot it out of the sky. It could also potentially verify the identity of the delivery recipient via an app, speech recognition, or a remote operator communicating with the recipient.”*

## I.21 – Amazon is destroying competition with its private label goods.



Image 21

*Happy Belly is Amazon's brand of snack foods.*

One of the most fascinating implications for this new-fangled advertisement (which instead of advertising *consideration*, facilitates a *purchase*) is that it could alter the importance of some of the more easily commoditized brands inside, say, that Amazon Drone order for your son's school supplies, which Amazon has already customized to your conversation. Take Sharpie markers. Maybe you really love the feel of Sharpie markers, and buy them for your home office. But perhaps this Amazon technology—the stuff that's used predictive, deductive logic to piece together a perfect order of the things your son needs for his report—has added a new Amazon brand of what looks like a Sharpie-style marker in your cart. Are you really going to take the time to change the order? Most likely, not always. Which brings us to another tool in the Amazon war chest...

### *The Brand & Company Destroyer: Amazon & Private Label*

“Amazon has roughly 100 private label brands for sale on its huge online marketplace, of which more than five dozen have been introduced in the past year alone... In just a few years, AmazonBasics [has] grabbed nearly a third of the online market for batteries, outselling both Energizer and Duracell on its site.”

JULIE CRESWELL, THE NEW YORK TIMES<sup>45</sup>

Third-party sales are one (hugely powerful) thing, but what about private label? How many brands will Amazon cannibalize with its acquisition of Whole Foods?

The number is anyone's guess, but the 2018 Prime Day made Amazon's intentions clear: private label is an important part of their strategy.<sup>46</sup> The differentiating point for this year? Amazon pushed its private label brands hard. From food to shoes to jewelry to digital assistants, Amazon's private labeling is making expansive moves.

Amazon's "test and learn" company strategy seems to have made an excellent lab for creating new private label brands, which unlike the legacy model of private label brands, do contain some elements of traditional branding. The logos, nomenclature and packaging all look higher end than, say, a Stop & Shop private label brand from the 1990s.

## I.22 – Amazon is taking over the battery market.



Image 22

*AmazonBasics batteries grabbed a third of the battery market within a few years of launching. Image source: Idealing.*

We call these brands “blands,” or bare-minimum brands that don’t spend on TV and print advertising, but look more sophisticated than the average private label.

Numerous Amazon protocols sell customers the Amazon bland over another brand. For example, saying “Alexa, order AA batteries” will get you Amazon Basics batteries, not Duracell.<sup>47</sup>

The huge potential becomes obvious. Per the *New York Times*:<sup>48</sup>

“*Analysts predict that nearly half of all online shopping in the United States will be conducted on Amazon’s platform in the next couple of years. That creates a massive opportunity for Amazon to more than double revenue from its in-house brands to \$25 billion in the next four years, according to analysts at SunTrust Robinson Humphrey.*”

JULIE CRESWELL



## I.23 — Brandless sells goods that are void of the hidden costs you pay for a national brand.



Image 23

Goods sold by brandless for \$3 each. Source: HiConsumption.

### *The Battle of Brands vs. Blands*

Amazon isn't the only player in the bland market.

The emergence of the website Brandless was one of the big marketing stories of 2017. In a seeming retort to both online mega-retailers like Amazon and basic CPG brands like Pepsi, Colgate and Folgers, Brandless.com sells goods void of what it calls the “BrandTax™,” their term for “the hidden costs you pay for a national brand.”

Every good sold on Brandless.com costs \$3, touts a transparent production line, and is designed in the same clean layout in the same Neutral family of fonts. Brandless sells vegan goods, kosher goods, and goods with no added sugar. Theirs is a compelling strategy, and worthy of any marketer's close attention.

Of course, seasoned marketers were fast to note that Brandless is indeed a brand—just look at its standardized aesthetic, its clear purpose, its sharply defined market strategy—but perhaps Brandless marks the dawn of a different kind of brand. Blands are brands for the minimalist, Millennial age; they follow a very new set of rules, with lessons for all of us.

I.24 – Blands pride themselves on communalism, or sameness, and feel fresh to an inundated generation.



Image 24

*Allbirds shoes come in just a handful of styles. Image source: Men's Journal.*

From a manufacturing standpoint, a bland is proudly reductionist, utilizing the full power of technology to minimize its footprint, production cost, and distribution strategy. Blands have a clear purpose for social good—usually some combination sourcing transparency, fair wages and a minimum viable carbon footprint—and blands are uninterested in extraneous marketing costs.

From a marketing standpoint, blands eschew frivolous social media presence beyond perfunctory announcements of, say, a new product, or a customer survey. And most fascinatingly, instead of selling individualism, blands pride themselves on selling communalism, or sameness. *Wear this shoe, which is same as many other people's shoe*, blands tell us, *Because this shoe is ethical and good, and that's far more important and intelligent than some nonexistent guileless expression of your "uniqueness."*

Blands often appeal to Millennials because their approach feels extremely fresh. After an age where brands made increasing bold claims and associations, blands come with a much smaller footprint. *Hey there, don't wanna tell you how to live, just want to be a really yummy soda*, a Brandless soda seems to whisper to its drinker. There's immense value in that sort of messaging, in a world where many feel inundated.

Blands are by no means a be-all, end-all solution to consumer packaged goods. If anything, they simply open the aperture to potential.

## I.25 – Artist Jennifer Lyn Morone turned herself into a corporation.



Image 25

*The artist has turned herself into a registered company. Image source: The Guardian..*

### *The Future of the Ad & Present of the Ad: Amazon is Currently Profiting from Both*

Amazon's advertising business might seem counterintuitive to its private label business. After all, advertising most often requires competition: buy my shoes because they're better than the other guy's shoes! So what gives?

Amazon is currently making revenue from selling both the private label good (the Amazon Basics battery) with the branded good, plus advertising to the branded good (the banner that Energizer buys each month that sits atop the Amazon Basics buy buttons—at a reported price of seven figures per year).<sup>49</sup> This is like Nike making money by selling Nike, but also selling an ad for Adidas. This is unprecedented, and it also feeds capital back into Amazon in an unprecedented way. The more revenue, the more profit, and the more cash with which to invent new things.

### *The Role of Your Data in this Ever-Expanding Universe*

Amazon's business, like Facebook's and Google's, is nothing without access to troves and troves of your personal data. As of now, these companies have gotten by without much pushback, offering us services for free in exchange for wildly long Terms of Service agreements which none of us bother to read.

But, amid the Facebook stock dip, and as *The Economist* recently questioned, what if people pushed back?<sup>50</sup> What if we were truly paid for our data, as a form of remuneration and protection? As the piece points out, data “It would not be the first time that an important economic resource had gone from simply being used to being owned and traded; the same has already happened with land and water, for example.”

“If AI lives up to the hype, it will lead to demand for more and better data. As AI services get more sophisticated, algorithms will need to be fed a higher-quality diet of digital information, which people may only provide if they get paid. Once one big tech firm starts paying for data, others may have to follow.”



“I want to say to you as I move to my conclusion from here?” that we must honestly face up to the question of restructuring the way we live with the million poor people here, and one day we must face the question of the million poor people in America?” And we are raising a question about the economic structure of our wealth. When you ask that question, you are

And I'm simply saying that more and more we are talking about the whole society. We are called the free market life's marketplace. But one day we must come to realize that the beggars needs restructuring. It means that we must, my friends, when you deal with this you must ask the question, “Who is the oil?” You begin to ask the question, “Why is it that people have to pay for water?” These are words that must be said

MARTIN LUTHER KING JR., AUGUST 16, 1967

*clusion, as we talk about “Where do we go  
the fact that the movement must address  
whole of American society. There are forty  
must ask the question, “Why are there forty  
when you begin to ask that question, you  
c system, about a broader distribution of  
begin to question the capitalistic economy.*

*more, we’ve got to begin to ask questions  
upon to help the discouraged beggars in  
ome to see that an edifice which produces  
at questions must be raised. And you see,  
begin to ask the question, “Who owns the  
o owns the iron ore?” You begin to ask the  
ay water bills in a world that’s two-thirds  
id.”*

**In Conclusion:**  
*The Adultings Will Be All Right*

Amazon will grow, and grow, and they will alter the world.

In response, Millennials will move politically left. They will have no choice but to impart elements of socialism into the world around them. Behemoths will rule our corporate future as, like dinosaurs from the Jurassic Era, the environmental economic conditions are ripe for them. We can live very well amid these hyper-efficient giants if we can distribute the riches they create.

In the 1990s, the Swedish sociologist Gøsta Esping-Andersen suggested a model called “de-commodification of labor.” What he meant was that if the state provides for basic human needs (healthcare, housing, etc.) then people won’t have to take jobs that pay unfairly, like millions currently do at Walmart. This society is still capitalist. However, the labor is partially de-commodified—or less potent because it’s slightly less necessary. Those who wish to become wealthy are free to do so, but for those who can’t pursue such dreams due to sickness or other limitations are still cared for. This is the model closer to many countries in Western Europe where high standards of living are enjoyed.

Keynes’ argument—and Adam Smith’s argument—was that technology should provide the respite from labor for such an admirable society to be entirely possible. This was capitalism’s dream! It was always to be means to an end, a temporary fix before a better alternative. The Millennials are heading there.

That the world is unequal, that we desire for something more—these are the truths we hold inevitable. This is the direction in which Millennials are heading, as they throw their support behind politicians like Alexandria Ocasio-Cortez. And all signs point to Generation Z—whose political life has begun remarkably strong, and remarkably young, via efforts like March for Our Lives—being even more strident.

In the meantime, multiple industries will completely disappear, or change form. Advertising will mutate into something incredible: something we can barely recognize today. Many CPG brands will disappear to Amazon “blanding” and private labeling. Amazon will turn its Whole Foods locations into modified Amazon Gos. Whereas Walmart attempted to replace the town square, Amazon will attempt something vastly larger, replacing as much of industry as possible: and delivering it straight to your door, or picnic blanket, via a drone.

Millennials will be asked to thrive in this new world—socially and economically—and they will use their status as the most educated generation in American history to rise to this occasion.



04 SOURCES

# Endnotes

*Further Reading*



## Endnotes

- 1 Leslie, Jess Kimball. *States of the American Millennial*, Ogilvy Consulting, 2015.
- 2 Brill, Stephen. *Tailspin: The People and Forces Behind America's Fifty-Year Fall—and Those Fighting to Reverse It*, New York, Knopf, 2018.
- 3 M, S. "Why Aren't the Poor Storming the Barricades?" *The Economist*, January 21, 2014.
- 4 Autor, David, et al. "Concentrating on the Fall of the Labor Share," *National Bureau of Economic Research*, January 2017.
- 5 Chen, Michelle. "Millennials Are Keeping Unions Alive," *The Nation*, February 5, 2018.
- 6 Bivens, Josh, et al. "How Today's Unions Help Working People," Economic Policy Institute, August 24, 2017.
- 7 Stewart, Emily. "Walmart is Paying \$20 Billion to Shareholders. With That Money, It Could Boost Hourly Wages to Over \$15." *Vox*, Updated May 30, 2018.
- 8 Rushing, Justin. "Why We're Helping More Customers Scan and Go," *Walmart Today*, January 9, 2018.
- 9 Popova, Maria. "Economic Possibilities for Our Grandchildren: A Hopeful Vision for Post-Occupy Humanity circa 1930." *Brainpickings*. July 19, 2012. Accessed: September 5, 2018. <https://www.brainpickings.org/2012/07/19/economic-possibilities-for-our-grandchildren-keynes-1930/>
- 10 Delaney, Kevin J. "The Robot that Takes Your Job Should Pay Taxes, Says Gates." *Quartz*, February 17, 2017.
- 11 Zwolinski, Matt. "The Libertarian Case for a Basic Income," *Libertarianism.org*. December 5, 2013. Accessed: September 5, 2018. <https://www.libertarianism.org/columns/libertarian-case-basic-income>
- 12 Gonella, Catalina. "Survey: 20 Percent of Millennials Identify as LGBTQ." *NBC News*, March 31, 2017.
- 13 Johnson, Amy. "Adulthood is Hard: Anxiety and Insecurity in the Millennial Generation's Coming of Age Process." (Honors Thesis, Wellesley College, 2017)
- 14 Wang, Xiaowei R. "Letter from Shenzhen," *Logic*, Accessed September 8, 2018. <https://logicmag.io/04-letter-from-shenzhen/>
- 15 "America's Tech Giants Vie with China's in Third Countries," *The Economist*, July 5, 2018.

- 16 Hawkins, Andrew J. "Waymo's Autonomous Cars Have Drive 8 Million Miles on Public Roads," *The Verge*, July 20, 2018.
- 17 Levine, Steve. "In China, a Picture of How Warehouse Jobs Can Vanish," *Axios*, June 13, 2018.
- 18 Picchi, Aimee. "America's Employment Problem Isn't in Manufacturing," CBS News, November 14, 2017.
- 19 Tiku, Nitasha. "The Second Class Citizens of the Google Cafeteria," *Gawker Valley Wag*, December 19, 2013. Accessed September 10, 2017. <http://valleywag.gawker.com/the-second-class-citizens-of-the-google-cafeteria-1486447319>
- 20 Burns, Alexander. "There is a Revolution on the Left. Democrats are Bracing," *New York Times*, July 21, 2018.
- 21 Gstalter, Morgan. "Democratic Socialists of America See Membership Spike After Cortez Win," *The Hill*, June 28, 2018.
- 22 Smarsh, Sarah. "Liberal Blind Spots Are Hiding the Truth About 'Trump Country,'" *New York Times*, July 19, 2018.
- 23 Illing, Sean. "Bullshit Jobs: Why They Exist and Why You Might Have One," *Vox*, June 25, 2018.
- 24 Keegan, Marina. "Even Artichokes Have Doubts," *Yale Daily News*, September 30, 2011.
- 25 Schiller, Ben. "The Fight for the \$400 Billion Business of Immigrants Sending Money Home," *Fast Company*, April 28, 2017. Accessed September 11, 2018. <https://www.fastcompany.com/3067778/the-blockchain-is-going-to-save-immigrants-millions-in-remittance-fees>
- 26 Hufford, Jillian. "Amazon Statistics: Need to Know Numbers About Amazon," N Channel, January 24, 2018. Accessed: Septebmer 11, 2018. <https://www.nchannel.com/blog/amazon-statistics/>
- 27 "Billionaire Jeff Bezos: Amazon's Journey to Now and Its Future," Interview by *Investors Archive*, May 20, 2017. <https://www.youtube.com/watch?v=zfEp1qVf5yY>
- 28 Fottrell, Quentin. "Jeff Bezos: Amazon Employees Should Start Meetings By Reading Memos 'With the Clarity of Angels Singing.'" *Market Watch*, April 19, 2018.

## Endnotes

- 29 Bomey, Nathan. "Average Age of Cars on U.S. Roads Break Record," *USA Today*, July 29, 2015.
- 30 Kulp, Patrick. "Amazon Has Its Eye on the Car Market in Next Step Toward World Domination," *Mashable*, July 25, 2017.
- 31 Kulp, Patrick. "Amazon Has Its Eye on the Car Market in Next Step Toward World Domination," *Mashable*, July 25, 2017.
- 32 Sweeney, Pete. "JEDI Cloud Tricks," *Reuters BreakingViews*, August 14, 2018.
- 33 Frey, Carl B. and Michael A. Osborne. "The Future of Employment: How Susceptible Are Jobs to Computerisation?" University of Oxford, September 2013.
- 34 Cohen, Patricia. "'Superstar Firms' May Have Shrunk Workers' Share of Income," *New York Times*, March 8, 2017.
- 35 Williams, Joan C. *White Working Class: Overcoming Class Cluelessness in America*, Harvard Business Review Press, 2017.
- 36 Clinton, Hillary R. *What Happened*, Simon & Schuster, 2017.
- 37 Meyer, Robinson. "How to Fight Amazon Before You Turn 29," *The Atlantic*, July/August 2018.
- 38 Meyer, Robinson. "How to Fight Amazon Before You Turn 29," *The Atlantic*, July/August 2018.
- 39 Harris, Adam. "White College Graduates Are Doing Great With Their Parents' Money," *The Atlantic*, July 20, 2018.
- 40 Stewart, Emily. "Poll: More Americans are Hitting the Streets to Protest in the Era of Trump," *Vox*, April 7, 2018.
- 41 Basu, Zachary. "March For Our Lives Grows to a Multi-Million Dollar Operation," *Axios*, July 22, 2018.
- 42 Miller, Andrea. "Amazon Patent Reveals 'Voice Sniffer Algorithm' That Could Analyze Conversations," *ABC News*, April 3, 2018.
- 43 Levy, Ari. "Amazon's Sellers Are Going Global, Helping the Company Generate Big Profits," *CNBC*, April 26, 2018.

- 44 Austin, Patrick Lucas. "Amazon Patent Points to Future in Which Humanity is Reduced to Screaming at Drones," *Gizmodo*, March 22, 2018.
- 45 Creswell, Julie. "How Amazon Steers Shoppers to Its Own Products," *New York Times*, June 23, 2018
- 46 Versace, Christopher. "Amazon Aims to Boost Sales of Its Private Label Products This Prime Day," *The Street Real Money*, July 17, 2018.
- 47 Creswell, Julie. "How Amazon Steers Shoppers to Its Own Products," *New York Times*, June 23, 2018
- 48 Creswell, Julie. "How Amazon Steers Shoppers to Its Own Products," *New York Times*, June 23, 2018.
- 49 Creswell, Julie. "How Amazon Steers Shoppers to Its Own Products," *New York Times*, June 23, 2018
- 50 "What If People Were Paid for Their Data?" *The Economist*, July 7, 2018.

Robot illustrations by Margaret Kimball.

Ogilvy